



2012

A NEW SIMULATION-BASED CONFLICT INDICATOR AS A SURROGATE MEASURE OF SAFETY

Chen Wang

University of Kentucky, chen.wang2013@yahoo.com

Recommended Citation

Wang, Chen, "A NEW SIMULATION-BASED CONFLICT INDICATOR AS A SURROGATE MEASURE OF SAFETY" (2012).
Theses and Dissertations--Civil Engineering. 3.
http://uknowledge.uky.edu/ce_etds/3

This Doctoral Dissertation is brought to you for free and open access by the Civil Engineering at UKnowledge. It has been accepted for inclusion in Theses and Dissertations--Civil Engineering by an authorized administrator of UKnowledge. For more information, please contact UKnowledge@lsv.uky.edu.

STUDENT AGREEMENT:

I represent that my thesis or dissertation and abstract are my original work. Proper attribution has been given to all outside sources. I understand that I am solely responsible for obtaining any needed copyright permissions. I have obtained and attached hereto needed written permission statements(s) from the owner(s) of each third-party copyrighted matter to be included in my work, allowing electronic distribution (if such use is not permitted by the fair use doctrine).

I hereby grant to The University of Kentucky and its agents the non-exclusive license to archive and make accessible my work in whole or in part in all forms of media, now or hereafter known. I agree that the document mentioned above may be made available immediately for worldwide access unless a preapproved embargo applies.

I retain all other ownership rights to the copyright of my work. I also retain the right to use in future works (such as articles or books) all or part of my work. I understand that I am free to register the copyright to my work.

REVIEW, APPROVAL AND ACCEPTANCE

The document mentioned above has been reviewed and accepted by the student's advisor, on behalf of the advisory committee, and by the Director of Graduate Studies (DGS), on behalf of the program; we verify that this is the final, approved version of the student's dissertation including all changes required by the advisory committee. The undersigned agree to abide by the statements above.

Chen Wang, Student

Dr. Nikiforos Stamatiadis, Major Professor

Dr. Kamyar C. Mahboub, Director of Graduate Studies

A NEW SIMULATION-BASED CONFLICT INDICATOR AS A
SURROGATE MEASURE OF SAFETY

DISSERTATION

A dissertation submitted in partial fulfillment of the
requirements for the degree of Doctor of Philosophy in the
College of Engineering
at the University of Kentucky

By

Chen Wang
Lexington, Kentucky

Director: Dr. Nikiforos Stamatidis, Professor of Civil Engineering
Lexington, Kentucky

2012

ABSTRACT OF DISSERTATION

A NEW SIMULATION-BASED CONFLICT INDICATOR AS A SURROGATE MEASURE OF SAFETY

Traffic safety is one of the most essential aspects of transportation engineering. However, most crash prediction models are statistically-based prediction methods, which require significant efforts in crash data collection and may not be applied in particular traffic environments due to the limitation of data sources. Traditional traffic conflict studies are mostly field-based studies depending on manual counting, which is also labor-intensive and oftentimes inaccurate. Nowadays, simulation tools are widely utilized in traffic conflict studies. However, there is not a surrogate indicator that is widely accepted in conflict studies.

The primary objective of this research is to develop such a reliable surrogate measure for simulation-based conflict studies. An indicator named Aggregated Crash Propensity Index (ACPI) is proposed to address this void. A Probabilistic model named Crash Propensity Model (CPM) is developed to determine the crash probability of simulated conflicts by introducing probability density functions of reaction time and maximum braking rates. The CPM is able to generate the ACPI for three different conflict types: crossing, rear-end and lane change.

A series of comparative and field-based analysis efforts are undertaken to evaluate the accuracy of the proposed metric. Intersections are simulated with the VISSIM micro simulation and the output is processed through SSAM to extract useful conflict data to be used as the entry into CPM model. In the comparative analysis, three studies are conducted to evaluate the safety effect of specific changes in intersection geometry and operations. The comparisons utilize the existing Highway Safety Manual (HSM) processes to determine whether ACPI can identify the same trends as those observed in the HSM. The ACPI outperforms time-to-collision-based indicators and tracks the values suggested by the HSM in terms of identifying the relative safety among various scenarios. In field-based analysis, the Spearman's rank tests indicate that ACPI is able to identify the relative safety among traffic facilities/treatments. Moreover, ACPI-based prediction models are well

fitted, suggesting its potential to be directly link to real crash. All efforts indicate that ACPI is a promising surrogate measure of safety for simulation-based studies.

KEY WORDS: Crash surrogate, Crash modeling, traffic conflicts, VISSIM, SSAM

Chen Wang

12/14/2012

A NEW SIMULATION-BASED CONFLICT INDICATOR AS A
SURROGATE MEASURE OF SAFETY

By

Chen Wang

Dr.Nikiforos Stamatiadis

Director of Dissertation

Dr.Kamyar C. Mahboub

Director of Graduate Studies

12/14/2012

To my daughter

ACKNOWLEDGEMENTS

First and foremost, I thank Dr.Nikiforos Stamatiadis, who served as the chair of my advisory committee and provided me invaluable support during the past three years of my studies at the University of Kentucky. I also express my sincere appreciation to Dr.Mei Chen, Dr.Jerry Rose, and Dr.Cidambi Srinivasan, who also served on my advisory committee. These professors not only helped this document become a reality, but also provided continuing support personally and professionally during my academic life at the University of Kentucky.

This dissertation would not have been accomplished without the help of Mr.Adam Kirk who guided me at various stages of my research. I thank Nithin K. Agarwal for taking time out of his busy schedule to help me with VISSIM and for troubleshooting whenever I faced problem. I also appreciate the support provided by all the staff members in Civil Engineering department –Ms. Shelia Williams, Ms. Betty Berry and Ms. Suzy Wampler and also the staff members of the Kentucky Transportation Center Library – Ms. Laura Whayne and Ms. Victoria Brock who helped me with obtaining various resources.

Finally, I thank my family – my father, Min Wang for his ever-lasting Inspiration and my mother Lili Wang, for all the inspiration and unconditional support provided from day one to over 27 years now. Without my family’s continuous love and support I could not have accomplished any of my dreams including this document. I also thank my wife Chen Chen and my daughter Olivia Wang who are always bringing me the love, laughter, encouragement and inspiration which stimulates me to complete my goals and accomplish this dissertation. I am

indebted to all these people and other members whom I have not mentioned here for helping me throughout my journey to achieve my dreams. Thank you, all!

Chen Wang

TABLE OF CONTENTS

ACKNOWLEDGEMENTS.....	iii
TABLE OF CONTENTS.....	v
LIST OF TABLES.....	vii
LIST OF FIGURES.....	viii
1 INTRODUCTION.....	1
1.1 BACKGROUND AND CONTEXT.....	1
1.2 OBJECTIVES AND CONTRIBUTIONS.....	3
1.3 OVERVIEW OF DISSERTATION.....	3
2 LITERATURE REVIEW.....	5
2.1 TIME-BASED INDICATORS.....	5
2.1.1 Time-to-Accident.....	5
2.1.2 Time-to-Collision.....	6
2.1.3 Post-Encroachment Time.....	8
2.2 SPEED-BASED INDICATORS.....	8
2.2.1 Deceleration Rate to Avoid the Crash (DRAC).....	8
2.2.2 Other speed-based indices.....	10
2.3 OTHER INDICATORS.....	10
2.4 METHODOLOGIES.....	11
2.5 SIMULATION-BASED ANALYSIS.....	13
2.6 SUMMARY.....	15
3 AGGREGATE CRASH PROPENSITY INDEX AND CRASH PROPENSITY MODEL 17	
3.1 BASIC CPM CONCEPT.....	17
3.2 CPM PROCEDURES.....	22
3.3 REQUIRED BREAKING RATE.....	26
3.3.1 Crossing Conflict.....	27
3.3.2 Rear-End Conflict.....	28
3.3.3 Lane Change Conflict.....	29
3.4 EXAMPLE APPLICATION OF ACPI DERIVATION.....	31
3.5 CPI AND TTC.....	33
3.6 SUMMARY.....	37
4 SIMULATION-BASED COMPARATIVE ANALYSIS.....	39
4.1 OVERVIEW.....	39

4.2	SAFETY COMPARISON BETWEEN PROTECTED/PERMITTED LEFT TURNS	39
4.2.1	Ratio Comparison	42
4.2.2	Rank Comparison	44
4.3	SAFETY COMPARISON BETWEEN INTERSECTIONS WITH/WITHOUT RIGHT TURN LANES	47
4.3.1	Ratio Comparison	49
4.3.2	Rank Comparison	51
4.4	SAFETY COMPARISON BETWEEN INTERSECTIONS WITH/WITHOUT DEDICATED LEFT TURN LANES	53
4.4.1	Ratio Comparison	55
4.4.2	Rank Comparison	57
4.5	CONCLUSION	59
5	FIELD DATA-BASED ANALYSIS	60
5.1	OVERVIEW	60
5.2	DATA COLLECTION	60
5.3	STATISTICAL COMPARISONS	64
5.4	ACPI-BASED PREDICTION MODELS FOR FOUR-LEG SIGNALIZED INTERSECTIONS	67
5.5	DISCUSSION AND SUMMARY	69
6	ESTIMATION OF CRASH SEVERITY THROUGH CPM	71
6.1	OVERVIEW	71
6.2	THE PROCESS OF ACQUIRING A SURROGATE INDICATOR OF CRASH SEVERITY THROUGH CPM MODEL	71
6.3	CONCLUSION	73
7	CONCLUSIONS AND FUTURE RESEARCH	74
7.1	CONCLUSIONS	74
7.2	RECOMMENDATIONS AND FUTURE RESEARCH	75
	APPENDIX A: MATLAB CODE	77
	REFERENCES	80
	VITA	84

LIST OF TABLES

Table 2.1 DRAC and Conflict Levels	10
Table 4.1 ACPI for Protected/Permitted Left Turn Volume Combinations by Conflict Type.....	41
Table 4.2 Ratio Comparison between ACPI, TTC-Based (<1.5s), and Predicted Crash Frequency (HSM2010)	43
Table 4.3 Ratio Comparison between ACPI, TTC-Based (TTC<1.5s), and Predicted Crash Frequency (HSM 2010)	46
Table 4.4 ACPI for With/Without Right Turn Volume Combinations by Conflict Type	48
Table 4.5 Ratio Comparison between ACPI, TTC-Based (<1.5s), and Predicted Crash Frequency (HSM 2010)	50
Table 4.6 Ratio Comparison between ACPI, TTC-Based (<1.5s) and Predicted Crash Frequency	52
Table 4.7 ACPI for With/Without Left Turn Volume Combinations by Conflict Type.....	54
Table 4.8 Ratio Comparison between ACPI, TTC-Based (<1.5s), and Predicted Crash Frequency (HSM 2010)	56
Table 4.9 Rank Comparison between ACPI, TTC-Based (TTC<1.5s), and Predicted Crash Frequency (HSM 2010)	58
Table 5.1 Selected Intersections Characteristics and Three-Year Crashes.....	63
Table 5.2 ACPI, PACF (HSM) and ACF (Historic) of the twelve intersections	65
Table 5.3 Statistical Results of Correlation and Spearman Rank Correlation for ACPI and PACF	66
Table 5.4 ACPI-based Regression Models.....	67

LIST OF FIGURES

Figure 2.1 Time-To-Accidents versus Conflict Speed (Archer, 2005).....	6
Figure 2.2 Speed Versus Required Braking Rate (Archer, 2005)	12
Figure 3.1 Group A and Group B (the RTD follows a lognormal distribution)	19
Figure 3.2 Group B-1 and Group B-2(the MADR follows a truncated normal distribution)	20
Figure 3.3 Maximum Available Braking Distance Database (Source: MOV'IT).....	23
Figure 3.4 The Run of a VISSIM model.....	24
Figure 3.5 Surrogate Safety Assessment Model	25
Figure 3.6 The process of a Crossing Conflict.....	28
Figure 3.7 The process of a Rear-End Conflict.....	29
Figure 3.8 The Process of A Lane Change Conflict.....	30
Figure 3.9 The Change of Lateral/Longitudinal Speed during A Lane Change Conflict.....	30
Figure 3.10 CPI versus TTC for Crossing Conflicts.....	35
Figure 3.11 CPI versus TTC for Rear-End Conflicts	35
Figure 3.12 CPI versus TTC for Lane Change Conflicts.....	36
Figure 5.1 the US31E in Bardstown, Kentucky	60
Figure 5.2 the KY74 in Bardstown, Kentucky.....	61
Figure 5.3 the US31W in Elizabethtown, Kentucky.....	61
Figure 5.4 the crash predictions (95% confidence interval) and the actual crash frequency	68

1 INTRODUCTION

1.1 BACKGROUND AND CONTEXT

Traffic safety is one of the most essential aspects of transportation engineering. The planning, design, and maintenance of transportation facilities should consider the impact of crashes when designing or evaluating alternative designs. Since crashes are a direct measure of traffic safety, the development of crash prediction models is able to give policy-makers, planners and traffic engineers a clear insight into past, current and future safety. Hence, crash prediction models play a very important role in safety study and need to be carefully examined to ensure their accuracy and reliability.

Most of the traditional crash prediction models depend heavily on historical crash data. In order to develop reliable and accurate models, crash databases need to be large enough requiring decades of data accumulation and maintenance. The recently published Highway Safety Manual (HSM) proposed Safety Performance Functions (SPF) along with crash modification factors (CMF) for crash prediction, the development of which took approximately twenty years (Haas, 2009). However, the reliability and validity of the models need to be further investigated and improved. One important question deals with the issue of whether SPFs can be useful at any locations around the world. Most of the SPFs and CMFs are developed based on data from the United States and therefore, calibration is essential to apply these in other locations or countries. Since traditional safety studies are timely and require significant efforts to collect and maintain the appropriate data, the development of surrogate measures is necessary for predicting crashes and evaluating traffic safety due to the difficulty of crash data collections. Tarko et al. (2009) stated two basic requirements for surrogate measures. The first is that a surrogate measure should be derived from observable non-crash events which can be correlated with crashes. The second is that the relationship between non-crash events and related crash frequency and/or severity can be quantified by some practical method. Hence, surrogate measures of safety are expected to be developed for crash predictions instead of the traditional crash data collection.

Amundsen and Hyden (1997) defined traffic conflict as “an observable situation in which two or more road users approach each other in space and time to such an extent that there is a risk of crash if their movements remain unchanged.”

Hyden (1987) addressed two advantages of traffic conflict as a surrogate measure. Firstly, traffic conflicts are more frequent traffic incidents compared with traffic crashes. Thus, the difficulty of observing traffic conflicts is much lower than collecting traffic crashes. Secondly, traffic conflicts have been proved to share the approximate severity distribution with crashes. Till now, traffic conflicts are still believed to be the best surrogate measure for crashes.

Studies on traffic conflicts are expected to be a supplementary method of traditional statistical-based safety studies. Traditionally, traffic conflicts are observed based on manual counting and estimation, which are time-consuming, labor-intensive and sometimes inaccurate (due to the bias introduced by different observers). Recently, video techniques have been introduced to reduce the labor cost and improve the data accuracy due to its automatic data collection mechanism. With this improvement, a number of methods have been developed and some have shown potential to become “promising approaches” such as the Extreme Value Method (Tarko et al., 2009). However, as Tarko et al. (2009) concluded that reliable safety surrogates still need to be developed. They addressed that traditional field-based surrogates like speed and deceleration rate are not able to explain the complexity of crash causality and other explanatory variables need to be incorporated. Moreover, such field-based methods mostly require the identification of dangerous conditions (conflicts or near-crashes) by human judgment and thus could lead to bias and decrease the data accuracy.

In recent years, simulation tools have been utilized for traffic studies. With the development of computer technology, the simulated traffic environments are being close to the real world due to the rich set of input variables including traffic conditions, geometric layout and human factors. Simulation tools have the capability of automatically collecting simulated traffic data and determining potential traffic conflicts at the initial moment they occur. Lately, the Surrogate Safety Assessment Model (SSAM) has been developed which is capable of extracting the information of simulated traffic conflicts from trajectory outputs from simulation tools (FHWA, 2008). This development has enhanced the capability of studying traffic conflicts.

However there are still no appropriate methodologies and reliable surrogates for simulation-based conflict studies, although SSAM can be used to analyze every single conflict. Some researchers have developed dedicated simulation-based surrogates but none of them are extensively accepted and utilized (Ozbay et al., 2007; Cunto, 2008). These surrogates are limited to certain conflict types, which hinder them from being applicable to all case studies. In

the final report of SSAM, a simple traditional conflict indicator (the conflict number with Time-to-Collision (TTC) less than 1.5 seconds) is still used as the primary surrogate while disregarding other conflict information (FHWA, 2008). Moreover, the use of the Time-to-Collision (TTC) has produced some unexpected results limiting its wider acceptance. The authors emphasized the need of developing a compound surrogate metric taking advantage of the rich conflict information available through the simulation models (FHWA, 2008). Therefore, an appropriate method and a new simulation-based surrogate need to be developed and validated in order to fill the gap.

1.2 OBJECTIVES AND CONTRIBUTIONS

The primary objective of this study is to develop a new conflict indicator for simulation-based studies. This traffic conflict indicator is expected to take advantage of the data-processing of VISSIM and SSAM and explain traffic safety as a surrogate measure. The following specific objectives are to be accomplished:

1. Introduce a compound traffic conflict indicator, which is associated with traffic crash frequency, based on the characteristics of traffic conflicts;
2. Introduce the process of deriving the proposed traffic conflict indicator;
3. Validate the proposed conflict indicator as a qualified surrogate measure of crash frequencies for simulation-based conflict studies;

In this paper, all three objectives are accomplished. For the third objective, both theoretical validations and field validations are conducted and the results are considerably positive. The major contribution of this work is to provide a qualified traffic indicator that can well indicate traffic safety based on traffic simulations, instead of traditional crash prediction methods. This paper also presents the process of developing another conflict indicator that is associated with severe crash frequency.

1.3 OVERVIEW OF DISSERTATION

This dissertation is organized into six chapters.

Chapter 1 addresses the background, problem statement, research objectives, contribution of research, and the organization of the dissertation.

Chapter 2 includes a literature review of previous work on conflict study methods and identifies the areas where additional research is needed.

Chapter 3 introduces the new proposed conflict indicator, presents the basic concept of the new methodology, shows the entire process for estimating the indicator, and provides a simple example.

Chapter 4 presents three comparative analyses by examining safety among different scenarios. The purpose is to show the advantage of the proposed conflict indicator over traditional surrogate indicator in identifying safety effectiveness of traffic treatments.

Chapter 5 presents a field-based analysis to show the ability of the proposed conflict indicator to differentiate the safety among transportation facilities and be very highly correlated with real crash frequencies. Twelve four-leg signalized intersections are calibrated and simulated.

Chapter 6 presents a process of acquiring a surrogate indicator of crash severity through CPM model. DeltaV is introduced into the CPM model to determine the crash probability of a conflict turning into a severe crash (injury/fatal).

At last, conclusions, recommendations and future efforts are addressed in Chapter 7.

2 LITERATURE REVIEW

Over the past three decades, substantial efforts have been completed on determining and developing surrogate measures with the purpose of linking conflicts to real crashes in a decent manner. Various methodologies and indicators have been identified in previous research and these are described in the following sections.

2.1 TIME-BASED INDICATORS

2.1.1 Time-to-Accident

The Time-to-Accident (TA) indicator was initially proposed by Perkin and Harris (1967) and then was given a generally accepted definition by Amundsen and Hyden (1977) as “the time that passes from the moment that one of the road users reacted and starts braking or swerving until the moment the involved road user had reached the point of collision if both road users had continued with unchanged speed and direction”.

Time-to-Accident value is calculated with estimated distance and speed when the evasive action is initially identified by field observers. Traffic conflicts were determined as severe and non-severe and they are mapped in a two-dimensional conflict diagram with TTA value and maximum speed (Hyden, 1987).

Figure 2.1 shows the two-dimensional conflict diagram of conflict severity levels. In this figure, conflicts are categorized into six groups based on uniform severity level that is decided by the required deceleration rates, which are associated with TA and speed in a non-linear manner. The severity increases as the category goes from 1 to 6.

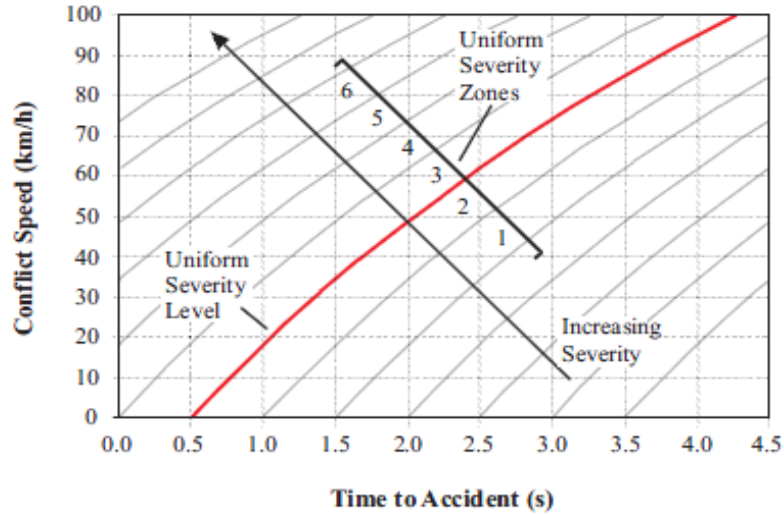

Figure 2.1 Time-To-Accidents versus Conflict Speed (Archer, 2005)

The bold line delineates the boundary of “severe” conflict and “non-severe” conflict. TA is a time-based indicator that also takes into account the impacts of speed-based indicator (speed and deceleration rate).

However, when looking into the definition of TA, the “evasive action” is initially identified by observers. Since different observers have different knowledge and understanding of “evasive actions”, the TA may vary by observers. This bias could be decreased to some extent by training observers. However, a new bias could also arise due to the different judgments of speed and distance (Hauer and Per Garder, 1986). This can be considered as the major drawback of this indicator because the bias in determining the speed and distance at the initial moment of “evasive actions” can directly affect the accuracy of TA.

2.1.2 Time-to-Collision

Time-to-collision (TTC) is a time-based surrogate indicator which was initially proposed by Hayward in 1972 (Hayward, 1972). It refers to “the time that remains until a crash between two vehicles would have occurred if the crash course and speed difference are maintained.” TTC was utilized by many researches for safety evaluation (Hyden, 1987; Hayward, 1972; Sayed et al., 1994; Hyden, 1996).

For vehicles maneuvering in the same direction, the TTC can be calculated by

$$TTC = \frac{(P_i - P_{i-1}) - L_i}{V_{i-1} - V_i} \quad (2.1)$$

Where,

P: position of the vehicles (i=leading vehicle; i-1=following vehicle)

L: vehicle length

V: velocity

For vehicles crossing with each other, the TTC can be derived by

$$TTC = \frac{D_{i,t}}{V_{i,t}} \quad (2.2)$$

Where,

$D_{i,t}$: distance between the project collision point and the initial point of vehicle i at time t;

V_{it} : the speed of vehicle i at time t

TTC is measured at the beginning of the conflict occurrence instead of the start of the “evasive action that can only be captured after the driver reacts. Compared to TA, TTC directly measures conflicts instead of traffic incidents with particular driver reactions. For instance, a drunk driver can make a conflict with a very high TTC (e.g. 5 seconds) into an incident with a very low TA (e.g. 1 second). To most road users, this conflict would be not dangerous according to the high TTC, despite of the low TA in this case.

Although TTC is a very simple time-based indicator and used widely, it still has obvious drawbacks. Using TTC threshold to identify conflicts could lead to a simple result that all conflicts with the same TTC are equally dangerous or could result in similar severity levels when TTC is the only safety indicator to measure the crash potential. TTC does not consider the potential evasive actions after the conflict occurrence. The fact is that drivers have varied reaction times and vehicles have varied braking abilities under different speed levels and traffic conditions. By admitting this fact, different conflict types can have different levels of crash potentials even with the same TTC. Even for the same conflict type, different speeds can pose different levels of difficulty for drivers to avoid the conflict as well as different levels of crash severity.

Another problem is that TTC requires a continuous measure of vehicle interactions. Observers need to keep observing the vehicles' trajectory, speed, distance and decide if the potential conflicts occur. This work is very labor-intensive when field observations are taken. Video-techniques also have problems in identifying TTC because “safety critical events can be difficult to detect in two-dimensional imagery” as Archer (2005) suggested.

Nowadays, simulation packages are widely used in studying conflicts and this problem may be resolved using the automatic “observation” and recording of conflicts through the simulation.

2.1.3 Post-Encroachment Time

Post-Encroachment Time (PET) is another time-based surrogate indicator. PET refers to the time lapse from the moment that the first vehicle departs a conflict point to the moment that second vehicle approaches that point (Songchitruksa and Tarko, 2006). This indicator has also been extensively utilized (Hyden, 1987; Hyden, 1996; Cooper, 1983; Van der Horst and Kraay, 1986).

The advantage of PET is that it has no speed and direction assumption like TTC. The measure of TTC requires the existence of a collision course assuming that both speed and direction of a vehicle are maintained. Without the assumption of the collision course, the PET appears to be relatively simple by not considering speed and distance.

The disadvantages of PET are the lack of consideration of speed and distance and therefore it neglects the influence of speed on traffic conflicts. The accuracy of this indicator is therefore reduced in terms of estimating crash frequency and resulting crash severity. PET performs better in analyzing crossing conflicts because it requires a certain conflict point being captured (Archer, 2005). When dealing with rear-end and sideswipe conflicts, the dynamic conflict points make it difficult to capture the minimum PET by traditional field observation and video techniques.

2.2 SPEED-BASED INDICATORS

Some researchers argued that determining conflict severity simply by time-based indicators neglects the impact of speed-based indicators (Kruyssen, 1991; Tiwari et al., 1995). The variance of speed reduction in a conflict may have significantly different impacts on its crash probability and crash severity. However, by applying only time-based indicators such as TTC, the influences of speed-related factors can be underrated or even neglected.

2.2.1 Deceleration Rate to Avoid the Crash (DRAC)

Cooper and Ferguson (1976) proposed a deceleration rate to avoid the crash (DRAC) in traffic conflict study in order to determine the conflict severity. DRAC is the minimum required

braking rate to be applied for a vehicle attempting to avoid the crash with other vehicles. Actually, the calculation of DRAC requires the assumption that one vehicle takes evasive actions while the other retains its speed and direction. For vehicles with the same direction, the expression of DRAC is:

$$DRAC_{i,t+1} = \frac{(V_{i,t} - V_{i-1,t})^2}{2[(P_{i-1,t} - P_{i,t}) - L_{i-1,t}]} \quad (2.4)$$

Where,

T: time interval;

P: position of the vehicles (i=the following vehicle, i-1=the leading vehicle);

L: vehicle length;

V: velocity.

McDowell et al. (1983) classified conflicts into five severity groups based on the values of DRAC. The DRAC increments are intuitively determined as the same (1.5 m/s²) between severity grades and the DRAC of 3.0 m/s² is considered as a boundary between severe and non-severe conflicts.

Hyden (1996) proposed another classification standard for traffic conflicts. The DRAC is calculated based on the expected driver reaction, vehicle speed, vehicle distance and so on. He classified conflicts into 6 groups. Table 2.1 shows the conflict levels, related DRAC and required reaction descriptions. The first two groups are determined as “no conflict” groups. From conflict level 1 to level 4, the DRAC is increasing and level 4 is the highest level that requires emergency reactions.

Table 2.1 DRAC and Conflict Levels

Conflict Level	DRAC	Description
No conflict	0	Evasive action not necessary
No conflict	0 to 1	Adaption necessary
1	1 to 2	Reaction necessary
2	2 to 4	Considerable reaction necessary
3	4 to 6	Heavy reaction necessary
4	≥ 6	Emergency reaction necessary

However, the current use of DRAC has some shortcomings. The first one is that the calculation of DRAC entails the detailed information of conflicts such as speed, reaction time, vehicles distance and so on. If real conflicts are studied, a significant effort is required for data collection and field observations. This may also lead to inaccurate or biased estimations of conflict information. Another downside is that the traffic conflicts are still intuitively divided into groups based on DRAC (Cunto, 2008). The development of the boundary values can be questioned, since additional evaluation may be needed to determine their accuracy.

2.2.2 Other speed-based indices

Other speed-based indicators have been developed in the past including Deceleration Rate (Malkhamah, Tight, and Montgomery, 2005), Deceleration-to-Safety Time (Topp, 1998), Speed Variance (Garber and Gadiraju, R., 1988; Evans, 1991), and Standard Deviation of Lateral Position (Vogel, 2003). However, none of them are developed aiming at directly estimating the real crash frequency.

2.3 OTHER INDICATORS

Other indicators have also been identified like queue length and stop-bar encroachments. However, no quantified relationship has been built between those indicators and conflict severity, although some of their research showed potential to deal with traffic safety (Perkins and Bowman, 1982; Thompson and Perkins, 1983; Fitzpatrick et al., 2000).

Noticeably, most of the research focused on the probability of a conflict turning into a crash without realizing that a conflict needs to be determined not only for its possibility to be a crash but also, and more importantly, for the potential to be an injury or even a fatal crash. Therefore, additional conflict characteristics need to be identified and investigated to allow for estimating the severity of a conflict once it becomes a crash. To be more specific, a conflict with a small possibility to be a crash but a very high likelihood to be a fatal crash requires more attention than a conflict with a larger possibility to be a crash but a very low likelihood to be a severe crash. However, limited research has been completed to develop indicators explaining the severity potential of a conflict. Only one composite indicator was identified to measure that characteristic using kinetic energy (Ozbay et al., 2008). They used inverse of Modified Time-to-Collision as the probability of crash and kinetic energy to represent the severity of crash. They developed a compound indicator by multiplying the two and provide a field validation. The indicator was able to explain the safety in a similar manner like real frequency does. However, the accuracy of the inverse of modified TTC that could explain the crash probability is unknown and the physical meaning of the combined indicator was not explained. Also only one field validation may not be sufficient enough to prove the reliability of this indicator since there are no following validation efforts afterwards. Finally, this indicator only deal with rear-end conflicts with the neglect of other conflict types.

2.4 METHODOLOGIES

In order to measure the indicators mentioned above, various methodologies also have been identified.

Traditional traffic conflict technique (TCT) classifies conflicts as severe and non-severe, using a “speed versus time to accident” graph. This graph (Figure.2.1) demonstrates a reasonable association among conflicts, time-to-accident (TA) and speed (Hyden, 1996). Conflicts with observed TA and speed can be mapped in this graph and severity can be determined. Although this graph is based on large amount of data collected, the reliability could be weakened due to the variability of observers’ perception on speed and distance (Hauer and Per Garder, 1986). More importantly, this graph fails to show the crash probability of a conflict quantitatively but provides an ordinal value associated with a specific level instead. Therefore, the application of this technique can be limited due to the lack of quantitative measure. Another methodology of traditional TCT uses TTC and PET instead of TA to analyze

conflicts (Archer, 2005). A threshold needs to be set up firstly to exclude conflicts exceeding the threshold and then the Required Braking Rate (RBR) is considered as an alternative surrogate measure of conflict severity based on a graph “Speed versus Required Braking Rate” (Figure 2.2). However, different thresholds for TTC have been identified in the literature (FHWA, 2008; Minderhoud and Bovy, 2001; Ozbay et al., 2008; Archer, 2005), including two studying simulated-based conflicts (FHWA, 2008; Ozbay et al., 2008). The variance of TTC thresholds may lead to different results. Besides, there is no guarantee that conflicts within a specific threshold all turn into crashes while those above the threshold do not. More importantly, the crash probability of each conflict cannot be derived precisely, for they are only classified into two categories: severe or non-severe. Therefore, this technique appears to be incapable of showing the linkage between simulated conflicts and real crashes.

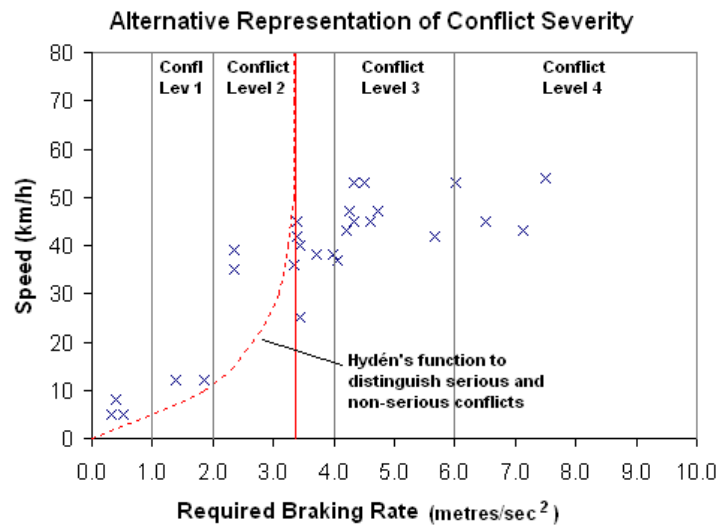

Figure 2.2 Speed Versus Required Braking Rate (Archer, 2005)

A probabilistic methodology also was introduced as a surrogate measure of safety by Davis, et al. (2008). The term named “near-crash” was introduced instead of conflicts. Near-crash refers to a traffic event which requires a sign of a strong evasive maneuver to avoid a crash. A strong evasive maneuver is determined as control behaviors which reach the limit of the vehicle capabilities. Near-crash events were observed on a freeway and initial vehicle speeds, distances, reaction times and deceleration rates are collected and extracted by video trajectory data. A function between crash probability and deceleration rates is developed based on the residual uncertainty of those estimates. Then, by applying the emergency braking distribution developed by Fambro et al. (1997), the probability of each event can be derived.

This methodology is able to estimate the probabilities of near-crash events, which appears to be more reasonable and promising than setting up a threshold for TTC or other indicators. The deficiency of this study is that the definition of near-crash itself is vague because the “strong evasive maneuver” is difficult to determine. If some deceleration threshold is set up for determining the “strong” magnitude, the same problem could occur similar with that identified using the TTC threshold. Besides, it only considers rear-end events that are only one conflict type. However, this study is very important because the idea of using a probabilistic model to deal with the danger of events provides an insight in conflict study. In real world, it is very difficult to decide when the conflict course occurs. However, in simulation environment, the computer is able to record all vehicles’ trajectory information automatically which allows the recognitions of conflict occurrence and further the development of probabilistic models.

Saunier and Sayed (2008) also present a probabilistic framework for determining the crash probability of conflicts. This framework is also based on field data by using an automated system that can extract detail information of vehicle movement and interactions from video trajectory dataset. This method needs to be further validated (Tarko et al., 2009).

Another noticeable methodology is called extreme value method (EVM) which has been widely utilized in estimating events with extreme low or high probabilities in other research areas. It was firstly introduced in 2004 in order to estimate the frequency of crashes (Songchitruksa and Tarko, 2004). Then, they applied this method to estimate right-angle crashes at signalized intersections (Songchitruksa and Tarko, 2006). Crossing conflicts with post-encroachment more than 6 seconds were observed and selected by video technique. In this case, EVM performed well with the frequency of crashes falling in the estimated confidence interval (95 percent) and showing its strength and potential to capture the relationship between conflicts and real crashes. However, EVM requires a large amount of field data to ensure its reliability although it appears to be a promising field-based conflict method.

2.5 SIMULATION-BASED ANALYSIS

With the rapid development in computing science, traffic simulation tools have been more extensively utilized. Traditional observation study and video techniques are costly and time consuming and are not able to provide accurate data (FHWA, 2008; Hyden, 1996; Minderhoud and Bovy, 2001; Ozbay et al., 2008; Archer, 2005; Davis, Hourdos, and Xiong, 2008; Fambro, Fitzpatrick, and Koppa, 1997; Songchitruksa and Tarko, 2004). Simulation tools are able to

build a roadway environment similar to that of the real world and collect a variety of data easier. Therefore, simulation tools have great potential in traffic conflict study (Archer, 2005).

A number of surrogate measures were developed recently for simulation-based conflict studies. Some measures are TTC-based composite indicators such as Time Exposed Time-to-Collision (TET) (Minderhoud and Bovy, 2001), Time Integrated Time-to-Collision (TIT) (Minderhoud and Bovy, 2001) and Crash Index (CI) (Ozbay et al., 2008). All these metrics utilize a TTC threshold which should be problematic due to its arbitrary setting. Some measures are only able to deal with particular conflict types such as Unsafe Density (UD) for rear-end conflicts (Barcelo et al., 2003), Potential Index for Collision with Urgent Deceleration (PICUD) for rear-end conflicts (Uno et al., 2002), An Accumulative Safety Indicator (J-value) for rear-end and lane change conflicts (Pham et al., 2007), Deceleration rate to avoid the crash (DRAC) for rear-end conflicts (Saccomanno et al., 2008), Crash Potential (CP) for rear-end conflicts (Saccomanno and Cunto, 2006), Criticality Index (CI) for left-turn conflicts (Chan, 2006), Crash Index (CI) for rear-end conflicts (Ozbay et al., 2008) and Crash Propensity Index (CPI) for angle and rear-end conflicts (Cunto, 2008).

Recently, the Surrogate Safety Assessment Model (SSAM) was developed to automatically calculate surrogate indicators utilizing the trajectory data generated by simulation tools. SSAM outputs two major types of surrogate indicators: indicators for conflict severity and indicators for severity of resulting crashes (FHWA, 2008). Time-to-Collision (TTC), Post Encroachment Time (PET), and Deceleration Rate (DR) are used as indicators for conflict severity while Maximum of the speeds of the two vehicles (MAXS) and Maximum relative speed (DeltaS) are indicators for determining severity of resulting crashes.

A recent report assessed and validated the SSAM outputs based on the data from simulation tools (FHWA, 2008). Field validation tests were conducted to compare the conflicts derived from SSAM with crashes. Eighty three four-leg signalized intersections in British Columbia and Canada were simulated using VISSIM and analyzed by SSAM. The significant correlations between predicted conflicts and real crashes were evaluated by several statistical tests including safety ranking by total incidents and incident types, regression model tests, and identification of incident prone locations. Total conflicts and conflict types were separately used to determine intersection rankings. Two rankings based on total conflicts and conflict types were respectively compared with the rankings based on the real crashes and crash types. Regression models were developed to establish a relationship between average hourly conflict

frequencies derived by SSAM and the estimated average hourly crash frequencies. Standard GLM procedures were also incorporated to establish conflict prediction models and crash prediction models. The results gave a correlation rate ($R=0.41$) between total conflicts and total crashes. The study also noted that based on the comparison between conflicts and crashes, conflict-to-collision ratios may vary by different types.

However, the analysis conducted by SSAM is based on a traditional traffic conflict technique methodology that is setting a threshold to determine conflict characteristics. This methodology encountered several problems:

1. Conflicts were filtered based on the threshold of TTC/PET which was arbitrarily determined in this study. The threshold of TTC/PET may overestimate or underrate some potential conflicts, because conflicts over the threshold may also be crashes while those within the threshold may not be crashes.

2. In reality, each conflict has a probability to be a crash. The probability of each conflict turning into a crash cannot be determined by the current methodology used.

3. Although some indicators have been provided to analyze the resulting crash severity, no quantified relationships had been proposed among these indicators and crash severity by current methodology used.

4. The correlation value ($R=0.41$) was lower than that between total crashes and traditional ADT based prediction models ($R=0.68$). Moreover, when SSAM was utilized to compare various design scenarios, controversial outputs led to inconclusive results. The comparison between two design scenarios appeared to be inconsistent between conflict severity and severity of resulting crashes.

Therefore, simply utilizing thresholds to determine conflicts is questionable and may not be capable of explaining the association between simulated conflicts and crashes. New methodology and surrogate indicators are expected to be developed for simulation-based studies, taking advantage of simulation tools and conflict data derived from SSAM.

2.6 SUMMARY

Previous research shows that significant efforts have been undertaken to estimate crash surrogate measures and a number of valuable results have been achieved. However, there are still some weaknesses and potential improvements can be identified:

1. Most of traditional surrogate methodologies are based on field observation and video technique, which are time-consuming, labor-intensive and often inaccurate;

2. The emerging simulation tools and SSAM have the potential to collect useful information for most of surrogate methodologies. The development and improvement of simulation tools can aid in collecting data more accurately and quickly. SSAM is a tool providing data extracted from traffic conflicts generated from simulation tools. However, current methodology utilized in simulated conflict analysis can be improved over the simple setting of time thresholds. Therefore, a more appropriate methodologies and a reliable surrogate indicator need to be developed for the simulation-based conflict studies. Moreover, the surrogate indicator should be able to deal with multiple conflict types in order to fill current gaps;

3. Reliable quantitative relationships have rarely been established between conflicts and crashes. That is, no reliable prediction models based on surrogate indicator have been developed so far.

Tarko et al. (2009) concluded that reliable safety surrogates need to be developed by incorporating explanatory factors into traditional indicators. In the final report of SSAM, the importance of developing a compound safety surrogate for simulation-based conflict studies is also demonstrated (FHWA 2008). To fill the gap, this research focused on developing an appropriate indicator (along with the methodology) for simulation-based conflict studies. The indicator and methodology will be presented and testified in the following chapters. Also, the prediction models based on the proposed indicator will be established and examined.

3 AGGREGATE CRASH PROPENSITY INDEX AND CRASH PROPENSITY MODEL

In this chapter, a new traffic conflict indicator named Aggregate Crash Propensity Index (ACPI) and a new model named Crash Propensity Model (CPM) will be introduced. CPM is a multi-step process that is able to use information from simulated traffic conflicts and compute ACPI that is a surrogate measure of real crash frequency.

3.1 BASIC CPM CONCEPT

As addressed in Chapter 2, simulation tools have become more and more powerful in developing traffic environments very similar to the real world. Moreover, computer science makes it easier, faster and more precise for data collection, compared to traditional field observation and manual counting. Hence, simulation tools have been extensively utilized in traffic operation studies, such as travel time and delay time collection.

However, problems arise when researchers apply simulation tools in traffic safety studies that simulation tools are basically designed for normal/safe traffic operations. In a microscopic simulation environment, drivers and vehicles are defined by and follow certain rules (acceptance gap, look ahead distance and fixed/zero reaction time etc.) and they always follow these rules (SSAM can get “simulated crash” but those are mainly caused by the internal malfunction of VISSIM (FHWA, 2008). For instance, drivers always react immediately (no reaction time considered) when they perceive the dangerous situation in VISSIM (some other simulation packages (e.g. Paramics) have reaction settings but only allow fixed values). However, it is not always the case in the real world. In the real world, some drivers react quickly while others react slowly. Even for the same driver, the reactions to conflicts may vary by time and space. Besides, vehicles have different braking limitations. Sometimes drivers escape the crash due to their vehicles’ braking capabilities while others are not able to do that. Crashes often happen because of driver’s fault (inattention) and vehicle’s poor performances. Those variations are not able to be reflected in simulation packages due to their design purposes for traffic operations.

To fill this gap, a simulation-based probabilistic model, called Crash Propensity Model (CPM), is developed to answer the question as to what is the crash probability of a simulated

conflict, without ignoring those significant variances such as reaction time and braking limitations. The CPM takes into account human/vehicle distinctions in conjunction with the simulated conflicts to decide how dangerous these simulated conflicts would be if they happen in the real world.

The CPM only focuses on conflicts between two vehicles. For each potential conflict, the vehicle which is supposed to reach first the conflict point will retain its speed during the process while the following vehicle (which is supposed to be the second vehicle arriving at the crash point) will apply the maximum braking once the driver reacts. This approach applies to most of rear-end and lane change conflicts, since drivers in the front do not realize the dangers behind. For crossing conflicts, it may not be clear whether the driver of the first vehicle (that arriving first at the conflict point) decelerates or accelerates. This study assumes that the first driver maintains the speed judging that he will cross first the conflict area and other vehicles should notice that and give him right-of-way. Since CPM only considers conflicts with short durations and high speed, drivers are believed to hit the brakes as much as they can in most of cases.

There can be countless scenarios for a single conflict, with various combinations of driver and cars going through it. In order to identify how many combinations can finally turn this conflict into a crash, CPM first separates drivers into Group A and Group B based on the minimum TTC of the conflict from SSAM. This TTC is unique for each conflict (i.e. no specific threshold is defined for all conflicts) and is equal to the one that could lead to a crash if no evasive actions are taken. Notably in SSAM, conflicts are continuously analyzed by the conflict courses and the derivation of minimum TTC is based on the assumption that “no reaction” is considered (FHWA, 2008). Figure 3.1 is a diagram of reaction time distribution which is determined to follow a log-normal distribution (See Chapter 3.2). It shows that drivers are divided into two groups by the boundary line which represents a TTC value. This boundary line is subject to change based on the unique TTC that each conflict has. Drivers in group A have reaction time larger than TTC and those in group B have reaction time less than TTC. Collisions will certainly happen for Group A because drivers are not able to perform any evasive actions during that conflict process. The number in group A is determined by the reaction time distribution of all drivers in the real world. The percentage of group A of all drivers can be calculated based on the reaction time distribution and TTC:

$$\text{Percent}(\text{Group A}): P(RT \geq TTC) * 100\% = \left\{ 1 - \left(\frac{1}{2} + \frac{1}{2} \text{erf} \left[\frac{\ln TTC - \mu_{rt}}{\sqrt{2\sigma_{rt}^2}} \right] \right) \right\} * 100\% \quad (3.1)$$

Where,

Erf(): the error function encountered in integrating the normal distribution;

μ_{rt} and σ_{rt} : parameters of reaction time distribution which is assumed to be a log-normal distribution;

RT: reaction time;

TTC: time-to-collision;

The reaction time distribution (RTD) was determined as log-normal distribution in previous research which is addressed in 3.2.

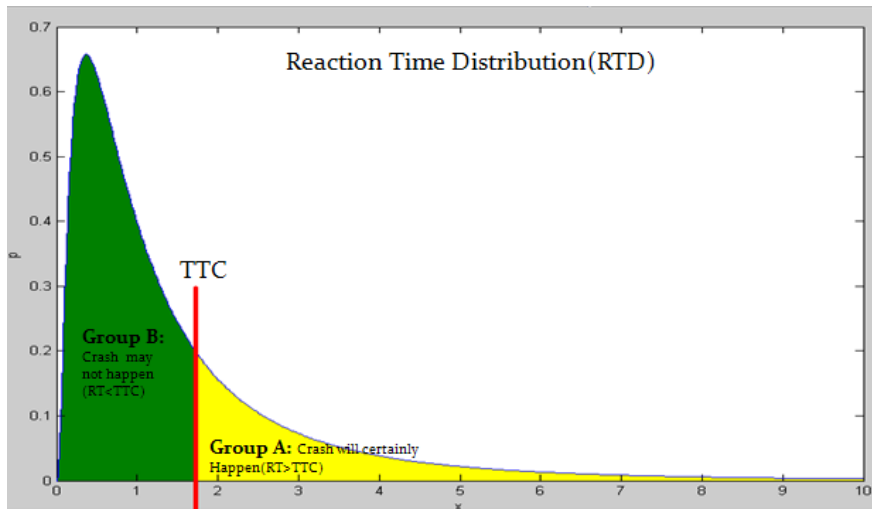

Figure 3.1 Group A and Group B (the RTD follows a lognormal distribution)

In group B, drivers can then be subdivided into two groups: Group B-1 and Group B-2 (Figure 3.2). Suppose a conflict would happen in 3 seconds (TTC=3 seconds) and a driver reacts 1 second after the conflict sequence begins. The driver then has 2 seconds to perform the evasive maneuver and avoid the crash. During this time (i.e. 2 seconds), the driver brakes and his vehicle performs as expected and avoids the crash. This calculating process is given in the following section. In this case the driver belongs to Group B-1. However, if the vehicle fails to perform as expected, i.e. does not meet the required braking rate (RBR), the conflict will turn into a crash and the driver will be in Group B-2. RBR is subject to change according to the unique characteristics of conflicts and reaction time of drivers. That is, the RBR is actually a function of reaction time. The calculation process of RBR function is discussed in 3.3. Simply, when the maximum available braking rate (MADR) of the vehicle exceeds the required

braking rate, drivers are in B-1 group or verse versa. Therefore, we need to examine Maximum Available Braking Rate Distribution (MADR) of cars in real world. Maximum Available Braking Rate for each car brand and type can be derived based on the MOV'IT database which records more than 500 hundred different types of automobiles. The distribution is inferred to be a truncated normal distribution with the mean and variance calculated by data in MOV'IT database. The lower and upper limits of MADR were also determined in order to avoid unrealistic MADR values.

Of interest here is to define the percentage of B-2 in all drivers, since only possible crashes are considered:

$$\begin{aligned}
 \text{Percentage}(\text{Group B2}) &= \text{Percentage}(\text{Group B}) * P(\text{MADR} < \text{RBR}) * 100\% \\
 &= \int_0^{\text{TTC}} \frac{1}{x\sqrt{2\pi}\sigma_{rt}^2} e^{-\frac{(\ln x - \mu_{rt})^2}{2\sigma_{rt}^2}} * \frac{\Phi\left(\frac{y - \mu_{\text{madr}}}{\sigma_{\text{madr}}}\right) - \Phi\left(\frac{L_{\text{madr}} - \mu_{\text{madr}}}{\sigma_{\text{madr}}}\right)}{\Phi\left(\frac{U_{\text{madr}} - \mu_{\text{madr}}}{\sigma_{\text{madr}}}\right) - \Phi\left(\frac{L_{\text{madr}} - \mu_{\text{madr}}}{\sigma_{\text{madr}}}\right)} dx * 100\% \quad (3.2)
 \end{aligned}$$

Where,

μ_{madr} and σ_{madr} : the parameters of maximum braking rate distribution (MADR) which is assumed to be a truncated normal distribution;

L_{madr} and U_{madr} : the lower limits and upper limits of MADR;

x : the reaction time of a driver;

y : the required braking rate (RBR) for a driver as a function of his/her reaction time (x);

$\Phi(\cdot)$: the cumulative distribution function of the standard normal distribution.

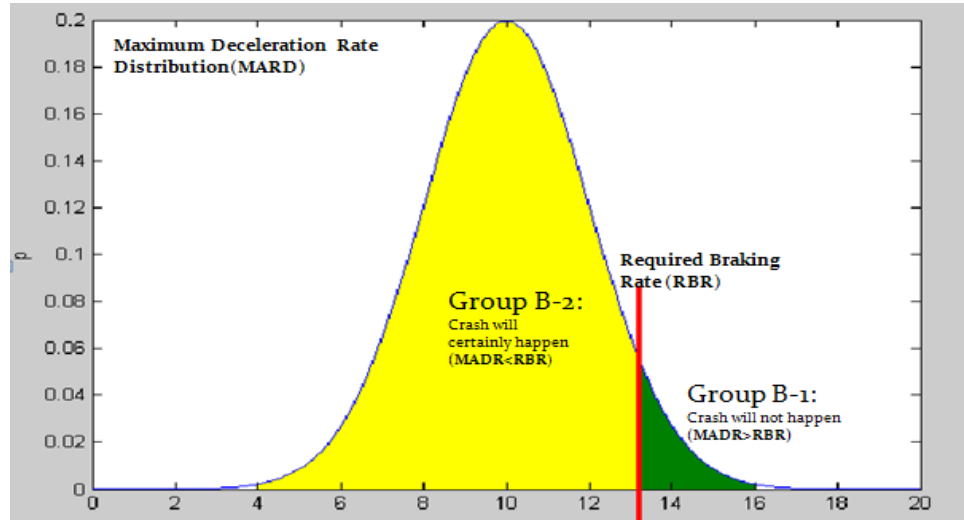

Figure 3.2 Group B-1 and Group B-2(the MADR follows a truncated normal distribution)

So the total percentage of Group A and Group B-2 is

y =

$$\left\{ 1 - \left(\frac{1}{2} + \frac{1}{2} \operatorname{erf} \left[\frac{\ln \text{MaxTTC} - \mu_{rt}}{\sqrt{2\sigma_{rt}^2}} \right] \right) + \int_0^{\text{TTC}} \frac{1}{x\sqrt{2\pi\sigma_{rt}^2}} e^{-\frac{(\ln x - \mu_{rt})^2}{2\sigma_{rt}^2}} * \frac{\Phi\left(\frac{y - \mu_{madr}}{\sigma_{madr}}\right) - \Phi\left(\frac{L_{madr} - \mu_{madr}}{\sigma_{madr}}\right)}{\Phi\left(\frac{U_{madr} - \mu_{madr}}{\sigma_{madr}}\right) - \Phi\left(\frac{L_{madr} - \mu_{madr}}{\sigma_{madr}}\right)} dx \right\} * 100\% \quad (3.3)$$

The total percentage of Group A and Group B-2 represents how many drivers in all would be involved in a crash when a particular conflict occurs. The percentage can be transformed into the proposed Crash Propensity Index (CPI) that indicates the crash probability of a conflict. For example, if a conflict has percentage of 87%, its CPI is 0.87. The Aggregate Crash Propensity Index is the aggregation of CPI of the conflicts belonging to the same category. For example, if an intersection has two crossing conflicts, with one CPI=0.5 and another CPI=0.2, the ACPI for crossing conflicts at that intersection is 0.5+0.2=0.7.

Notably, since the function is complicated, Monte-Carlo Integration methods will be introduced. In mathematics, Monte-Carlo integration method is an approach for integration by utilizing random numbers. This method is particularly useful for higher/complicated dimensional integrals. The basic concept of the Monte-Carlo integration is randomly distributing points over a simple domain D' (that is a superset of D) and counting the number (proportion) of points falling within D (Caflish, 1998). Consider the set D', subset of D on which the multidimensional definite integral

$$I = \int_{D'} f(\bar{x}) d\bar{x} \quad (3.4)$$

is to be calculated with known volume of D'

$$V = \int_{D'} d\bar{x} \quad (3.5)$$

Then sampling points on D': given N samples, $\bar{x}_1, \dots, \bar{x}_N \in D'$, I can be approximated by

$$I \approx V \frac{1}{N} \sum_{i=1}^N f(\bar{x}_i) \quad (3.6)$$

In this study, Matlab will be utilized to conduct this random process (Appendix A). For every single conflict, the Monte-Carlo Integration method takes one million repetitions (randomly assigning one-million points) to solve the integration (Equation 3.3) and derive its CPI.

3.2 CPM PROCEDURES

The development of CPM requires five steps:

1. Identify the Reaction Time Distribution from real world data;
2. Identify the Maximum Braking Distribution of various vehicle types as currently exist;
3. Identify the situation to be evaluated and perform simulation runs in VISSIM to obtain the trajectory output file;
4. Utilize SSAM to derive basic information of simulated traffic conflicts;
5. Employ CPM model to analyze traffic information, transform every single conflict into the new CPI indicator, and then aggregate them to get ACPI.

Step 1 and Step 2 are the fundamental parts of the process. The accuracy of distributions can affect the performance of the CPM model. In this research, the reaction time distribution is borrowed from existing research due to the limitation of data collection.

Step 1. Identify the Reaction Time Distribution from real world data.

The RTD was determined as log-normal distribution in previous research (Triggs and Harris, 1982; Taoka, 1989; Summala, 2000). This distribution will not be retested here because it needs to be derived either by driving simulators or field observations, both of which cost a lot of time and effort. Therefore, the results in the previous research were reviewed and appropriate log-normal distributions are assigned to different conflict types. Green (2000) suggested that the log-normal distributions for crossing and lane change conflicts are set to be with mean 1.3 sec and standard deviation 0.6 sec for the unexpected reaction distribution for drivers. The reason is that there is no dedicated reaction time distribution identified for both types. For rear-end conflicts, the log-normal distribution is utilized with mean 0.92 sec and standard deviation 0.28 sec, documented as a car-following reaction distribution by Triggs and Harris (1982).

Step 2. Identify the Maximum Braking Rate Distribution as currently exists.

Cunto (2008) examined the Maximum Braking Rates Distribution (MADRD) and derived a truncated normal distribution with a mean of 8.5m/s^2 and a standard deviation of 1.4m/s^2 for cars, by using MOV'IT database. The MOV'IT database contains the data of braking

performance for over five hundred different types of automobiles. Based on the data it provides, the maximum braking rate can be calculated by its braking distance (BD) from 100 km/h (27.8m/s) to 0 km/h (0 m/s) and MADR can be inferred. A 2011 update of the database revised these to a mean of 9.7 m/s² and a standard deviation of 1.3 m/s². The lower and upper limits were determined as 4.2 m/s² and 12.7 m/s² as suggested by Cunto (2008), in order to avoid unrealistic MADR values (e.g. negative numbers). Figure.3.3 shows the part of data provided by this database.

Model	100 kmh - 0 cold & empty	100 kmh - 0 warm + loaded	80% Vmax	MOV' IT	source
Alfa Romeo 166 3.0	41,5	43,3			AMS 11/98
Alfa Romeo 145 1,4 Twin	40,5				Auto Italia 03/97
Alfa Romeo 145 1,4 Twin	41,0	41,0			AMS 11/97
Alfa Romeo 146 1,6 Twin	40,8				Auto Italia 03/97
Alfa Romeo 156 1,9 JTD	41,5	43,8			AMS 12/98
Alfa Romeo 156 2,4 TD	42,9	48,1			AMS 06/98
Alfa Romeo GTV 2,0 TS	39,7				Auto Italia 03/98
Alfa Romeo Spider	51,4	40,6	160 kmh 106,2m		sportauto
Alfa Romeo Spider 2.0 TS	39,8	49,5			ams 10/99
Alpina B10 V8	37,1	38,5			
Aston Martin Vantage	41,9	47,0			Sportauto 07/98
Aston Martin DB7 Vantage	37,8	40,2	238 kmh 233m		
Audi A2	41,0	41,5			ams 17/2000
Audi A3 1,6	38,6	37,5			AMS 11/97
Audi A3 1,8	39,0	40,6			
Audi A3 T	37,8				Sportauto02/99

Figure 3.3 Maximum Available Braking Distance Database (Source: MOV'IT)

Step 3. Identify the situation to be evaluated and perform simulation runs in VISSIM to obtain the trajectory output file.

Figure 3.4 shows an example of VISSIM simulation. The models are to be developed using available data and several runs, i.e. repetitions of the model with different random numbers, should be conducted. The trajectory files for simulated vehicles are generated after the completion of the model runs.

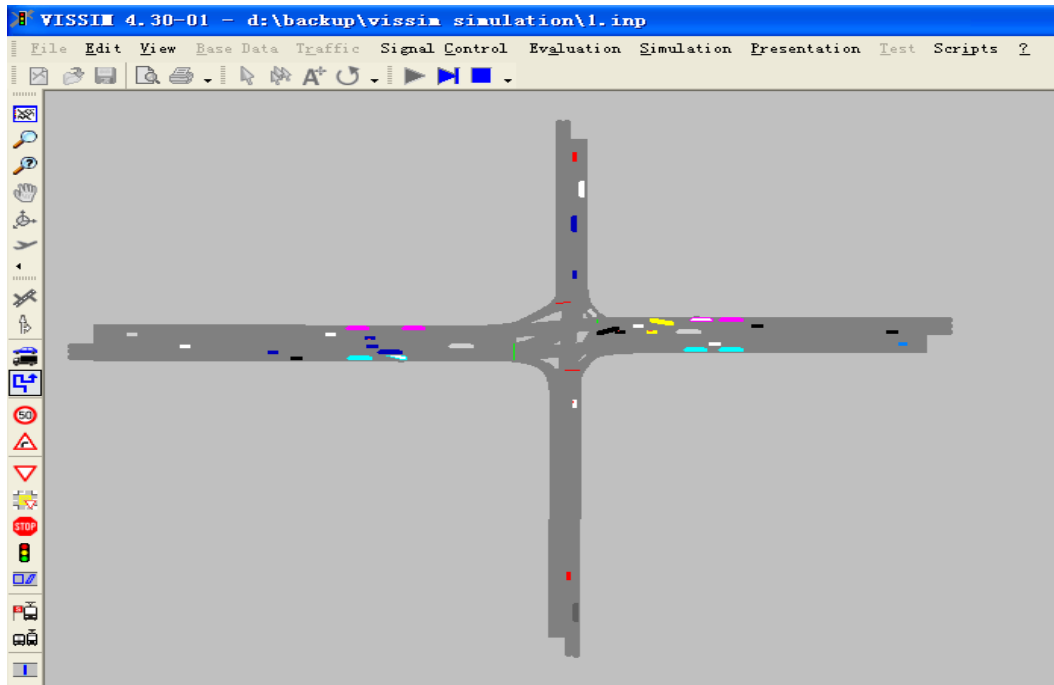

Figure 3.4 The Run of a VISSIM model

Step 4: Utilize SSAM to obtain basic information of simulated traffic conflicts

SSAM is a tool analyzing trajectory files generated from traffic simulations. SSAM is able to provide various data items for each conflict including TTC, PET, and DeltaV. Before conducting the CPM process, these data need to be extracted from the SSAM output. First, conflicts having TTC with 0 seconds need to be excluded because those are situations where the simulation tool fails to “accurately and completely represent the physical possibility of a particular maneuver” (FHWA, 2008). Then, TTC, FirstVMinTTC (the velocity of the first vehicle when the conflict occurs), SecondVMinTTC (the velocity of the second vehicle when the conflict occurs), and FirstLength (the length of the first vehicle), need to be extracted from the output. The final report of SSAM notes: “TTC is the minimum time-to-collision value observed during the conflict. This estimate is based on the current location, speed, and future trajectory of two vehicles at a given instant. A TTC value is defined for each time step during the conflict event.” This definition basically follows the traditional definition of TTC according to the analysis on collision courses.

With these data, additional important information regarding the vehicle positions and movements can be directly calculated. For example, there is a right angle crossing conflict.

Two vehicles are assumed to collide at the middle of the conflict area at TTC since there is no detailed information of projected collision position in SSAM. With the known FirstVMinTTC and FirstLength, the time duration that first vehicle occupies the conflict point can be derived.

$$T = \frac{\text{FirstVLength}}{2 * \text{FirstVMinTTC}} \quad (3.7)$$

If a conflict has TTC=1.5s, FirstVMinTTC =8m/s, SecondVMinTTC=10m/s, FirstLength=5m,

$$T = 5 / (2 * 8) = 0.3125s;$$

$$TTC + T = 1.5 + 0.3125 = 1.8125s;$$

Therefore, the second vehicle needs to take evasive action to ensure it will not reach the conflict point within 1.8125 s. If the vehicle arrives the conflict point after 1.8125 seconds, the crash could be avoided, while if it arrives within a shorter time, then there is a probability for a crash. The output of SSAM is shown in Figure 3.5.

trjFile	tMinTTC	xMinPET	yMinPET	TTC	PET	MaxS	DeltaS	DR	MaxD	MaxDeltaV	Conf
1.trj	23.00	-27.17	25.17	2.80	2.60	11.43	2.99	-1.38	-2.19	2.33	
1.trj	31.40	28.08	43.69	0.00	0.00	13.99	20.82	-0.31	-0.31	10.82	
1.trj	34.60	-45.43	23.91	3.50	1.80	12.09	1.32	-0.08	-2.22	0.69	
1.trj	45.00	-48.58	25.22	2.70	2.00	16.04	1.78	-0.69	-1.79	1.40	
1.trj	51.00	-5.62	21.66	2.30	2.20	3.59	3.59	-4.24	-4.24	2.83	
1.trj	58.00	-8.02	22.21	0.00	0.00	13.67	8.49	-0.22	-4.16	6.70	
1.trj	55.40	51.76	33.82	2.90	3.00	1.58	1.58	-1.44	-1.44	0.81	
1.trj	59.80	32.92	21.37	0.00	0.00	12.00	14.36	-0.03	-0.31	11.57	
1.trj	58.40	-6.81	21.67	3.10	3.00	10.80	8.67	-2.82	-3.16	6.89	
1.trj	58.40	-6.22	21.45	2.50	3.20	8.32	6.71	-5.44	-5.44	5.40	
1.trj	63.60	31.11	1.58	2.10	2.00	8.68	7.99	-0.09	-1.99	4.09	
1.trj	66.00	29.44	33.56	0.00	0.00	11.58	8.05	1.95	1.95	4.12	
1.trj	70.40	-51.37	35.92	1.60	1.60	7.07	7.07	-2.86	-2.86	5.83	
1.trj	74.60	101.59	23.12	0.00	0.00	8.52	8.52	-2.95	-2.95	6.89	
1.trj	76.40	32.65	36.24	0.00	0.00	13.82	16.14	-1.44	-2.60	13.02	
1.trj	80.00	-3.69	20.78	2.20	2.20	7.50	6.33	-1.26	-2.04	5.21	
1.trj	87.20	26.43	21.21	0.00	0.00	13.45	15.99	-0.27	-0.27	12.93	
1.trj	99.00	-54.59	18.23	0.00	0.00	5.88	0.66	2.90	2.90	0.54	
1.trj	102.40	90.46	40.82	3.50	3.40	4.48	4.02	-0.88	-0.88	2.01	
1.trj	106.40	29.65	36.87	0.00	0.00	14.16	8.78	0.10	0.10	4.66	
1.trj	104.40	-54.20	18.23	3.80	3.60	4.51	3.83	-0.81	-0.81	1.91	
1.trj	129.00	31.64	7.27	2.00	2.80	2.87	2.87	-1.47	-1.47	2.27	
1.trj	134.60	32.05	8.98	0.00	1.60	10.91	8.64	-4.79	-5.41	6.96	
1.trj	135.20	-46.30	21.03	2.40	1.20	11.61	9.86	-3.38	-3.38	7.91	
1.trj	133.80	89.32	37.32	2.90	1.40	13.69	0.19	-0.00	-1.63	0.10	
1.trj	141.20	101.19	23.12	0.00	0.00	8.43	8.43	-2.94	-2.94	6.82	
1.trj	140.60	44.33	33.82	2.20	2.40	3.75	3.60	-0.97	-1.09	2.86	
1.trj	146.60	-51.43	35.92	3.00	3.00	4.17	4.17	-0.87	-0.90	2.08	

Figure 3.5 Surrogate Safety Assessment Model

Step 5: Employ CPM model to analyze SSAM results, transform every single conflict into the new CPI indicator, and then aggregate them.

With the known conflict information, reaction time distributions and maximum braking distributions, CPM can be applied to determine the crash probability of each conflict. The CPM is a Monte-Carlo process randomly assigning one driver (with a randomly selected

reaction time according to the RTD) and one vehicle (with a randomly selected maximum braking ability based on the MADRD) to a conflict as one possible scenario and repeats it for millions of times. The CPM counts all scenarios leading to a crash and gets a proportion of all scenarios, which is CPI. Noticeably, some extreme cases (such as a drunk driver with reaction time more than 5 seconds or an older car with very poor braking performance) are also possible to be included since this is an overall random process based on the log-normal distributions for RT and normal distributions for MADR. The Monte-Carlo process will not only generate most of normal cases but also produce some extreme cases (e.g. there are about 95% of normal cases lying within 2 standard deviations of the mean and 5% of extreme cases out of that range for normal distribution, according to basic statistical knowledge.) Therefore, the CPI looks into each conflict and provides a general knowledge about crash potential. The CPI for each conflict will be automatically computed and aggregated by Monte-Carlo method (Monte-Carlo Code is shown in Appendix A). The Monte-Carlo Methods randomly distribute points according to the RT and MADRD distributions and repeat this process for millions of times. The CPI of each conflict reveals the proportion of points finally falls into the restricted area which represents the area of the integration domain of Equation 3.3.

3.3 REQUIRED BREAKING RATE

This section presents how to determine the RBR for each conflict type based on SSAM outputs. In order to simplify the calculation process, some clarifications and assumptions need to be addressed here. Firstly, the vehicle that is projected to be reaching the conflict point first is named Vehicle 1 while the second one is called Vehicle 2. Secondly, two vehicles are assumed to collide at the middle of the conflict area at TTC (for crossing and lane change) since there is no detailed information of projected collision position in SSAM. Thirdly, Vehicle 1 is assumed to have constant speed during the conflict. Finally, Vehicle 2 decelerates by its maximum braking rate once the driver reacts.

Conflicts can be classified into many types. The SSAM output categorizes conflicts into three major groups: crossing conflict, rear-end conflict and lane change conflict. Since conflicts vary by type, it is imperative to address the question whether two different conflict types would both lead to a crash when they have the same conflict attributes. It is very important to recognize that different types of conflicts need to be carefully examined and differentiated. Thus, the three types will be analyzed separately.

Notably for 3.3.1 to 3.3.3, l_i and w_i are the length and width of the vehicle I, V_i is the speed of vehicle I, D is the distance; and θ is the conflict angle.

3.3.1 Crossing Conflict

Figure 3.6 illustrates an on-going crossing conflict. Vehicle 2 must decelerate in order not to reach the conflict point before Vehicle 1 completely clears that point. The total time that Vehicle 1 occupies the conflict point is: $t = \frac{l_1 + \frac{w_1}{2 \cdot \tan \theta} + \frac{w_2}{2 \cdot \sin \theta}}{V_1}$. The critical condition for a crossing conflict is that the two are infinitely close to each other, which can be represented by the equation:

$$V_2 * \left(TTC + \frac{t}{2} \right) - \frac{1}{2} * a * \left(TTC + \frac{t}{2} - x \right)^2 \leq V_2 * TTC \quad (3.8)$$

The left side of (3.8) represents the distance that Vehicle 2 will travel at the last moment when Vehicle 1 is leaving the conflict point while the right side shows the distance between the two vehicles when the conflict occurs. This equation demonstrates the condition that Vehicle 2 will just reach the conflict point while Vehicle 1 just leaves it. According to the critical condition, the required braking rate (RBR) can be derived as:

$$RBR(crossing) = a \geq \frac{V_2 * t}{\left(TTC + \frac{t}{2} - x \right)^2} \quad (3.9)$$

If $a * (TTC + t - x) > V_2$, this condition shows that actually Vehicle 2 has been travelling at a negative speed at some point, which is impossible to happen. So the critical condition turns to: when Vehicle 2 reaches the conflict point, it stops. The required braking rate (RBR) turns into:

$$V_2 * x + \frac{V_2}{2} * \left(\frac{V_2}{a'} \right) \leq V_2 * TTC \quad (3.10)$$

The left side of (3.10) represents the distance that Vehicle 2 will travel when it stops and the right side of shows the distance between the two when the conflict occurs.

$$RBR(crossing)' = a' \geq \frac{V_2}{2 * (TTC - x)} \quad (3.11)$$

If the maximum braking rate of the Vehicle 2 fulfilled the minimum required braking rate, the crash would be prevented. Since for each case only x (reaction time) is the variable, the required braking rate is the function of reaction time (x).

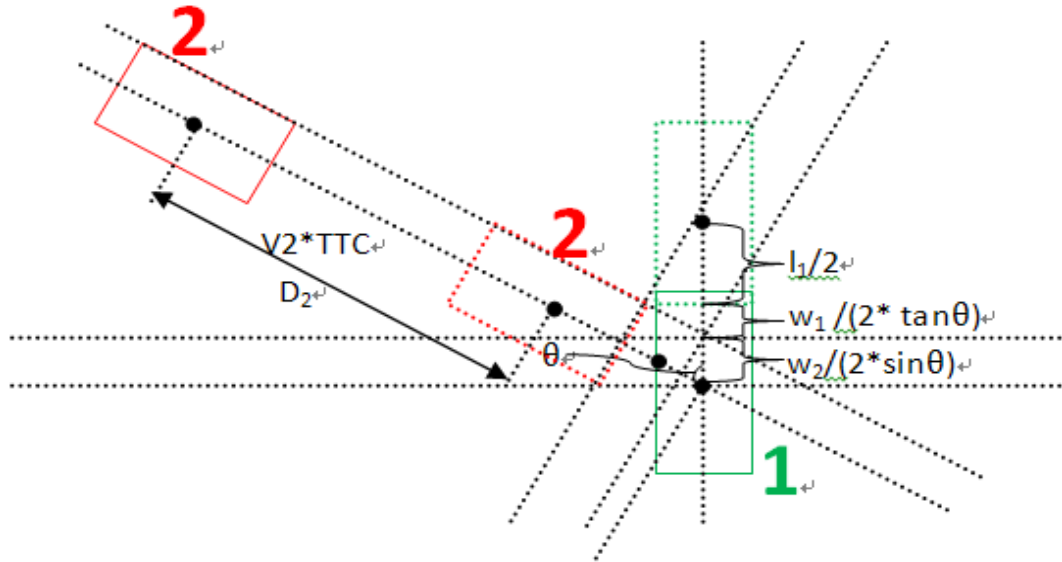

Figure 3.6 The process of a Crossing Conflict

3.3.2 Rear-End Conflict

Rear end conflicts are different from crossing conflicts because they have a series of conflict points instead of one single conflict point. Therefore, to prevent a rear end conflict, it is not enough to consider the initial conflict point. The critical condition of rear-end conflict is that two vehicles are infinitely close to each other while the Vehicle 2 behind slows down its speed to the same as that of Vehicle 1.

Figure 3.7 Shows the way rear-end conflict could take place. Vehicle 2 (following) and Vehicle 1 (leading) are in the same lane with distance headway $V_2 * TTC$. First of all, Vehicle 2 should decelerate in order not to reach the conflict point when Vehicle 1 occupies the conflict point. Moreover, if Vehicle 2 still keeps a larger speed than Vehicle 1 has after Vehicle 1 clears the initial conflict point, the rear-end crash is still possible to happen. Therefore, the critical condition is that when Vehicle 2 reduces its speed to be the same as Vehicle 1 and therefore, their distance headway reduces to zero. Suppose the reaction time is x and the required braking rate is a . The time is $t = x + \frac{(V_2 - V_1)}{a}$. According to the critical condition,

$$D_2 \leq D_{1-2} + D_1 - (l_1 + l_2)/2$$

$$\Rightarrow V_2 * x + \frac{V_2^2 - V_1^2}{2 * a} \leq V_2 * TTC + \frac{l_1 + l_2}{2} - V_1 * TTC + V_1 * \left(x + \frac{(V_2 - V_1)}{a} \right) - \frac{l_1 + l_2}{2}$$

$$\Rightarrow RBR(rear - end) = a \geq \frac{(V_2 - V_1)}{2 * (TTC - x)} \quad (3.12)$$

Where,

D_1 and D_2 : the distances which Vehicle 1 and Vehicle 2 travels when the critical condition happens;

D_{1-2} : the distance between Vehicle 1 and Vehicle 2 when the conflict occurs.

The minimum required braking rate is thus $\frac{(V_2 - V_1)}{2 * (TTC - x)}$. This is also a function of reaction time x as it was the case for the crossing conflict.

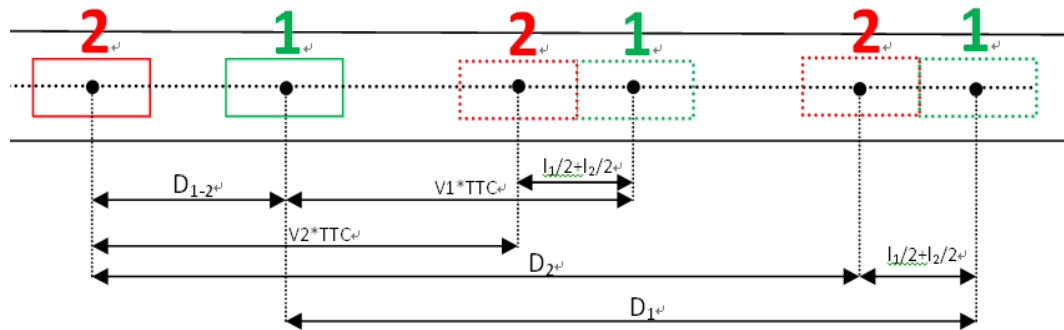

Figure 3.7 The process of a Rear-End Conflict

3.3.3 Lane Change Conflict

Lane change conflict may lead to either side-swipe crash or rear-end crash. Thus, it needs to be divided into two sub-conflicts: potential side-swipe conflict and potential rear-end conflict. Figure 3.8 shows the process of a lane change conflict. If two vehicles retain their velocity, the conflict will turn into a side-swipe crash at time TTC with angle θ . To avoid the side-swipe crash, Vehicle 2 needs to decelerate. Suppose Vehicle 1 keep its speed and the constant turning rate. At time T , when the conflict angle between the two vehicles turns to 0° , the sideswipe conflict ends and the rear-end conflict begins.

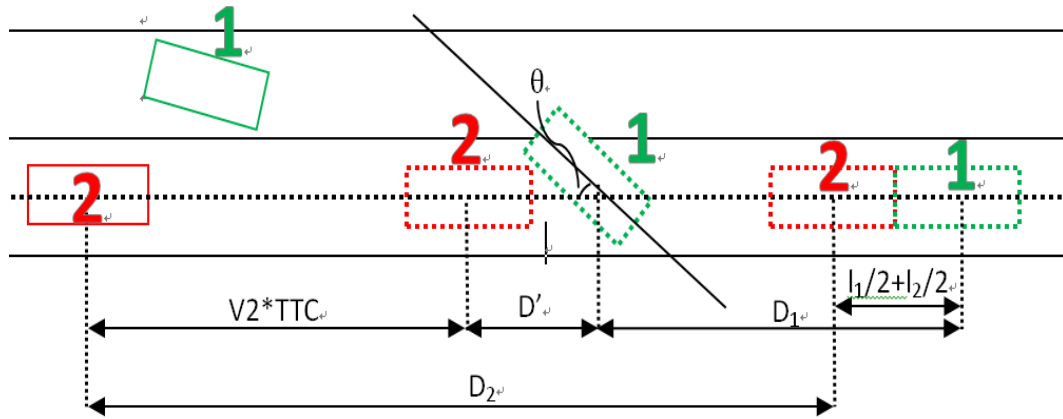

Figure 3.8 The Process of A Lane Change Conflict

During the lane change process, Vehicle 1 keeps its speed and constant turning rate. Figure 3.9 shows the changes of the longitudinal component of velocity and the lateral component of velocity during the lane changes conflict process. To calculate the turning time, the longitudinal distance is divided by the longitudinal velocity component.

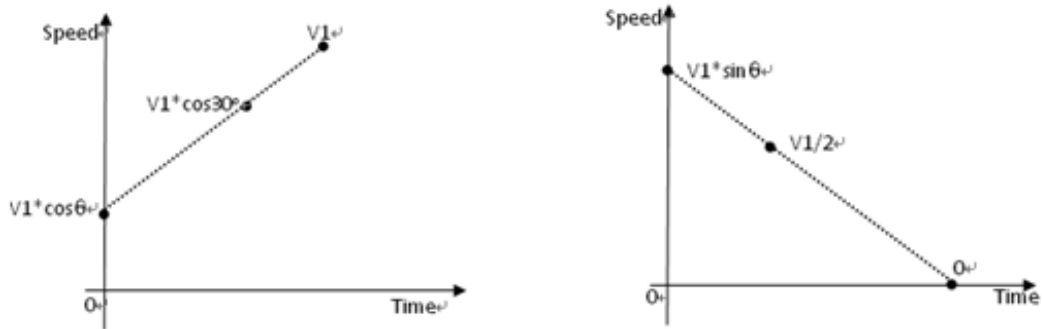

Figure 3.9 The Change of Lateral/Longitudinal Speed during A Lane Change Conflict

The time that Vehicle 1 uses to complete the lane change is $t = \frac{l_1 \sin \theta}{V_1 \sin \theta} = \frac{l_1}{V_1}$.

The critical condition for lane change crash (sideswipe) is that Vehicle 2 and Vehicle 1 are infinitely close at the moment when Vehicle 1 completes the lane changing movement. $D_2 \leq V_2 * TTC + D' + D_1 - \frac{(l_1 + l_2)}{2}$; Where D_2 is the distance traveled by Vehicle 2 right at the moment Vehicle 1 completes the lane change; D_1 is the distance traveled by Vehicle 1 during the lane change.

The required braking rate is:

$$RBR(\text{lane change}) = a \geq \frac{\frac{2V_2 l_1}{V_1} + l_2 - l_1 \cos \theta - \frac{w_1}{\sin \theta} - \frac{w_2}{\tan \theta}}{(TTC + \frac{l_1}{V_1}) - x)^2} \quad (3.13)$$

The critical condition for rear-end crash is that the Vehicle 2 reduces its speed to the same as Vehicle 1 when they are infinitely close. $D_2' \leq V_2 * TTC + D' + D_1' - \frac{(l_1+l_2)}{2}$

Where D_2' is the distance travelled by Vehicle 2 at the time Vehicle 2 decelerates its speed to the same as Vehicle 1;

D_1' is the distance travelled by Vehicle 1 at the time Vehicle 2 decelerates its speed to the same as Vehicle 1;

The required braking rate for this condition is:

$$RBR(\text{lane changed})' = a' \geq \frac{(V_2 - V_1)^2}{2 * \left(V_2 * TTC + (V_1 * \cos\theta + V_1) * \frac{2 * (\frac{l_1}{2} * \sin\theta) / (V_1 * \sin\theta + 0)}{2} + V_1 * x - V_1 * 2 * \frac{\frac{l_1}{2} * \sin\theta}{V_1 * \sin\theta} - \frac{l_1}{2} - \frac{l_2}{2} - V_2 * x \right)} \quad (3.14)$$

Thus, if the $MADR < \alpha$, the lane change conflict would happen; if the $MADR > \max(\alpha', \alpha)$, no crash would happen; $\alpha < MADR < \alpha'$, the rear-end crash would happen. Both α and α' are the function of reaction time(x).

3.4 EXAMPLE APPLICATION OF ACPI DERIVATION

The following example demonstrates the process of transforming a single rear-end conflict into CPI applying the process described in the previous sections (3.2 and 3.3).

Step 1. Identify the Reaction Time Distribution from real world data

In order to analyze a rear-end conflict, the lognormal distribution for car-following reaction time distribution will be used with mean 0.93s and standard deviation 0.28s (see 3.2).

Step 2: Identify the Maximum Braking Distribution of various vehicle types as currently exists

The MADR has been addressed in 3.2 as a normal distribution with a mean of 9.7 m/s² and a standard deviation of 1.3 m/s².

Step 3: Identify the situation to be evaluated and perform simulation runs in VISSIM to obtain the trajectory output file

This step is used to conduct the simulation runs for a case study which requires the establishment and calibration of VISSIM models. Hence, Step 3 will not be discussed here but in the next chapters where a series of validation efforts are presented and this step is shown as a part of it.

Step 4: Utilize SSAM to derive basic information of simulated traffic conflicts

A rear-end conflict (conflict A) extracted from SSAM has TTC=0.5s, FirstVMinTTC=8 m/s, and SecondVMinTTC=7.5m/s. With the known data items, the following parameters can be derived:

$$V_1=8\text{m/s}; V_2=7.5\text{m/s}; \text{ and } TTC=0.5\text{s}.$$

Notably, different parameters may be needed to derive required braking rate for different conflict types, according to 3.3.

Step 5: Employ CPM model to analyze traffic information, transform every single conflict into the new CPI indicator, and then aggregate them to get ACPI.

Those parameters will be input into CPM model. For Group A which has all drivers unable to react before the collision, the percentage can be calculated by equation (3.1):

$$\text{Percentage}(\text{Group A}): P(RT \geq TTC) * 100\% = \left\{ 1 - \left(\frac{1}{2} + \frac{1}{2} \text{erf} \left[\frac{\ln TTC - \mu_{rt}}{\sqrt{2\sigma_{rt}^2}} \right] \right) \right\} * 100\% = 50\%$$

This number indicates that 50 percent of drivers (Group A) are having a reaction time greater than 0.5s and they will be certainly involved in a crash without an evasive reaction.

For Group B, which has drivers taking evasive actions, the RBR can be written as the following with known MaxTTC, V(SecondVMinTTC) and L based on equation (3.12):

$$\begin{aligned} \text{RBR}(x) &= a \geq \frac{(V_2 - V_1)}{2 * (TTC - x)} \\ &= 0.25 / (0.5 - x) \end{aligned}$$

Here, x represents the reaction time variable. Then, the percentage of Group B-2, in which the RBR exceeds the braking capabilities, can be calculated based on equation (3.2):

$$\begin{aligned} \text{Percentage}(\text{Group B2}) &= \text{Percentage}(\text{Group B}) * P(\text{MADR} < \text{RBR}) = \\ &= \int_0^{TTC} \frac{1}{x \sqrt{2\pi\sigma_{rt}^2}} e^{-\frac{(\ln x - \mu_{rt})^2}{2\sigma_{rt}^2}} * \frac{\Phi\left(\frac{y - \mu_{madr}}{\sigma_{madr}}\right) - \Phi\left(\frac{L_{madr} - \mu_{madr}}{\sigma_{madr}}\right)}{\Phi\left(\frac{U_{madr} - \mu_{madr}}{\sigma_{madr}}\right) - \Phi\left(\frac{L_{madr} - \mu_{madr}}{\sigma_{madr}}\right)} dx * 100\% \\ &= \int_0^{0.5} \frac{1}{x \sqrt{2\pi(0.28)^2}} e^{-\frac{(\ln x - 0.93)^2}{2 * 0.28 * 0.28}} * \frac{\Phi\left(\frac{y - 9.7}{1.3}\right) - \Phi\left(\frac{4.2 - 9.7}{1.3}\right)}{\Phi\left(\frac{12.7 - 9.7}{1.3}\right) - \Phi\left(\frac{4.2 - 9.7}{1.3}\right)} dx * 100\% = 41.71\% \end{aligned}$$

Therefore, total percentage of Group A and Group B-2 is 50%+41.71%=91.71%. This percentage indicates that approximately 92% drivers will be involved in the crash if this conflict occurs. In this case, the CPI of this rear-end conflict is 0.9171 meaning that 91.71% of points finally falls within the restricted area according to Monte-Carol method.

If a simulation-based case study generate three rear-end conflicts and they have CPI 0.42, 0.64, and 0.12, the rear-end ACPI is the aggregation of CPI, that is $0.42+0.64+0.12=1.18$.

3.5 CPI AND TTC

Time and speed are considered as the two basic factors contributing to the crash probability of conflicts. However, most of the previously used time- or speed-based conflict indices are only associated with time or speed. This can generate bias because only one factor is considered while the influence of the other is unknown and cannot be interpreted properly.

One can anticipate that a crossing conflict and a lane change conflict with the same Time-to-Collision (TTC) are not equally dangerous. However, if using a time-based indicator, the difference between the two conflicts cannot be detected, since they have the same TTC. On the other hand, one can more easily estimate that two conflicts are equally dangerous if they have the same speed but different TTC. The basic concern here is that the level of dangerousness of conflicts varies with both TTC values and speeds and therefore, time and speed both play very important roles in conflicts. Hence, a good conflict indicator should consider the impacts of the two basic factors at the same time.

To better demonstrate the point that a good conflict indicator needs to be associated with both time and speed in a proper manner, a simple example is discussed below.

The example deals with comparing two rear-end conflicts with the same TTC and different speeds in order to determine the level of dangerousness of each conflict. For conflict A, the first vehicle drives at 10 m/s while the second vehicle drives at 20 m/s. For conflict B, the first vehicle has a 15m/s speed while the second vehicle has a 20m/s speed. The TTC for both conflicts are 1.5 seconds.

A simple examination of the TTC value will indicate that the two conflicts are exactly the same in regards to crash probability. However, the application of CPM indicates that their CPIs (based on equation 3.3) are different:

Conflict A: $CPI_a=0.3666$

Conflict B: $CPI_b=0.1285$

According to this, conflict A has a greater probability to become a crash because 36.66 percent of drivers will have the potential to be involved in a crash without an evasive action as compared to only 12.85 for conflict B. This indicates that even though both conflicts have the

same TTC, their likelihood to become a crash is different given their reaction of the drivers and the braking abilities of the vehicles.

The main question in this case is whether the results based on CPI are more reasonable than those based on TTC. To examine this, the required braking rate for both conflicts can be calculated based on the Equation (3.3), assuming that the reaction time for the following vehicles in both conflicts is 1s and that all vehicles have a 5m length:

$$\text{For conflict A: RBR} = (20-10)^2 / (2*(20*1.5+10*1-5-20*1)) = 3.33 \text{m/s}^2$$

$$\text{For conflict B: RBR} = (20-15)^2 / (2*(20*1.5+15*1-5-20*1)) = 0.625 \text{ m/s}^2$$

These values indicate that for the two cases, the required braking rate is different. One can tell that the conflict A is more dangerous than the conflict B for it requires a greater emergency braking rate and therefore it has a larger probability to exceed the braking capabilities of the vehicle. This example shows that although two conflicts have the same TTC, they have different levels of turning into a crash: a fact that TTC alone could not detect. Compared to TTC, CPI considers multiple factors such as time, speed, reaction time and braking rate, which at least identify the safety differences that TTC cannot detect.

According to the example demonstrated above, two conflicts with the same TTC can have different CPI. CPI is expected to show the crash probability of a conflict. Since TTC is a frequently used indicator (Archer, 2005) to explain the time factor of a conflict and CPI is the proposed indicator, a question arises as to whether there are any linkages between the two.

A simple four-leg signalized intersection (permitted left turn) was built in VISSIM model with all default parameters. This model is simulated with twenty-six repetitions with random seeds to gather sufficient traffic conflicts (at least more than 1000 for each conflict type). Conflicts are all analyzed by CPM in order to get the CPI and the CPI-versus-TTC graphs for each conflict type were developed. Figures 3.10, 3.11 and 3.12 show the CPI versus TTC for crossing, rear-end and lane change conflict types.

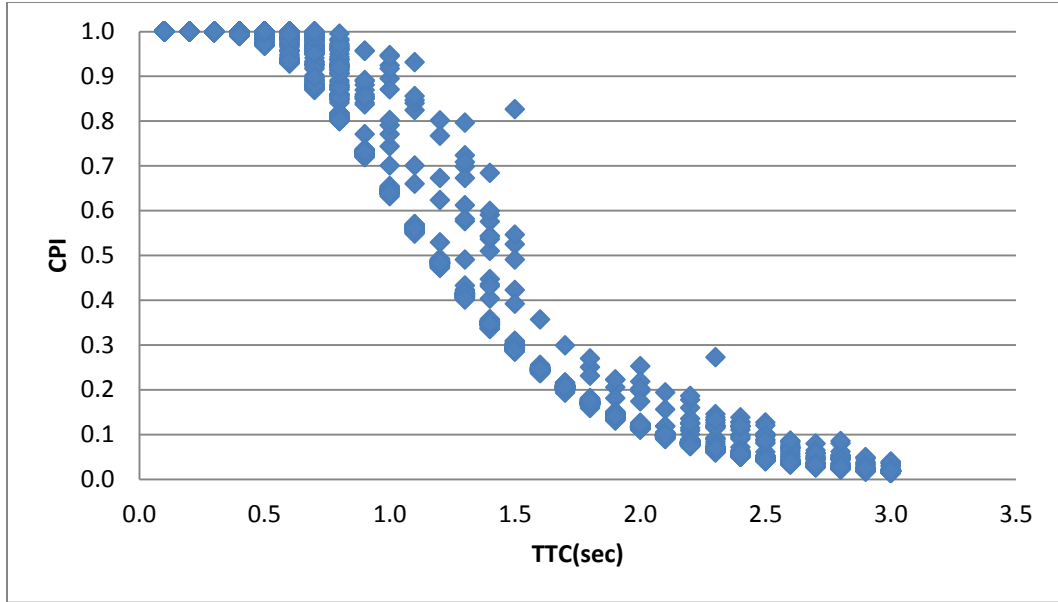

Figure 3.10 CPI versus TTC for Crossing Conflicts

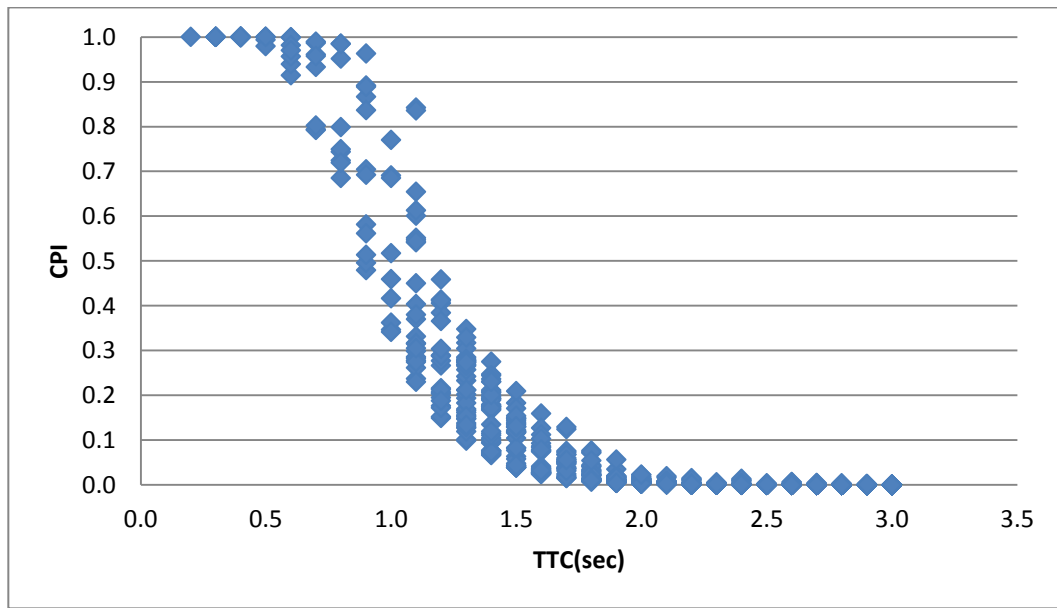

Figure 3.11 CPI versus TTC for Rear-End Conflicts

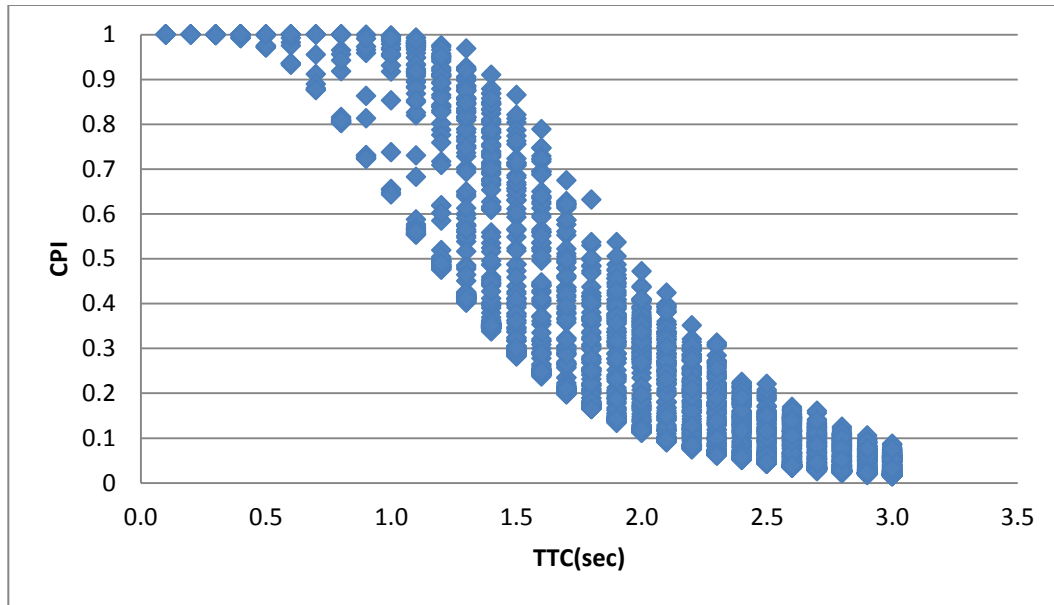

Figure 3.12 CPI versus TTC for Lane Change Conflicts

In general, the CPI decreases with the increase of TTC for all conflict types. The common knowledge is that higher TTC lead to lower crash probability. Traditional conflict studies extensively utilized TTC or TTC-based indicators to measure safety. A TTC threshold of 1.5 seconds was mostly applied in previous research (Archer, 2005, FHWA, 2008; Ozbay, et al. 2008). In the final report of SSAM, TTC of 1.5 seconds was set as a criterion to select dangerous simulated conflicts (FHWA 2008). The total count of the selected conflicts is used as a surrogate indicator that is expected to identify safety. However, the surrogates based on TTC selection criteria in simulation-based studies appeared to be unable to explain the real safety in a reliable way as it was noted by the FHWA that the count of rear-end conflicts are always much more than other conflict types, leading to unreasonable results compared to common knowledge (FHWA, 2008). A lot of identified rear-end conflicts with low TTC are actually low-speed events according to SSAM. Drivers may react more quickly during low-speed following events in the real world because they are expected to follow others with frequent braking actions, compared to those unexpected crossing conflicts. Therefore, a large number of rear-end conflicts cannot explain the true safety by neglecting other important factors such as speed and reaction time.

However, the CPI is a compound indicator including all those factors. The CPI versus TTC graphs could easily demonstrate that CPI can detect safety variances among different conflict types at the same TTC. According to CPI versus TTC graphs, rear-end conflicts could

be safer than other conflict types are, under the same TTC value. For instance, a crossing conflict with $TTC=1.5$ seconds has CPI ranging from 0.29 to 0.82, a rear-end conflict with the same TTC has a CPI range from 0.03 to 0.20 and a lane change conflict has CPI from 0.29 to 0.86. It is apparent that, rear-end conflicts with $TTC=1.5$ seconds could be safer than other conflict types for the minimum CPI of rear-end types is smaller. In general, the CPI of $TTC=1.5$ seconds has a broad range indicating that a conflict with $TTC=1.5$ seconds can be either safe (CPI=0.03 for a rear-end conflict) or very dangerous (CPI= 0.82 for a crossing conflict). All the variations are caused by the uncertainties of reaction time and braking limitations, which are very important but are not considered in TTC. Therefore, TTC has problem in correctly recognizing crash potential as a simple criteria.

Although these graphs cannot conclusively indicate that CPI is the most appropriate safety surrogate for simulation-based studies, it shows an advantage over TTC and thus has the potential to become a more reliable surrogate than TTC-based indicators.

3.6 SUMMARY

In this chapter, a surrogate indicator called CPI is introduced with the purpose of determining the crash probability of simulated conflicts. Due to the variances of drivers and vehicles in real world, a number of different conditions could happen when a certain conflict occurs. To explore the uncertainties, two important distributions are introduced: reaction time (RTD) and maximum braking (MADR). The RTD is utilized to address that different drivers could have different reaction time facing the same condition, due to complicated internal and external factors. The MADRD is used to demonstrate that vehicles have various braking performances, which can be significantly influence the outcome of a conflict. By applying Monte-Carlo Integration Method, a conflict can be analyzed in millions of possible scenarios by randomly assigning combinations of drivers (each has different reaction time based on RTD) and vehicles (each has various braking limitations based on MADRD). The CPI is derived from this process, indicating that how many scenarios of all can contribute to a crash.

An issue to be noted here is that this process does use a single TTC value to develop the CPI and the TTC for each potential conflict is calculated with the process described above. This is a significant departure from past research and provides a significant advantage over other efforts, since unique estimates are obtained for each specific conflict as obtained through simulation.

Moreover, the CPI is compared to TTC to show its capability of differentiating between conflict types with same TTC and allows for a better identification of potential crashes. The aggregation of CPI for each conflict type, i.e. ACPI, can be used to determine the total safety of a particular conflict type. It is expected that the ACPI could be directly linked to real crash frequency for each crash type.

4 SIMULATION-BASED COMPARATIVE ANALYSIS

4.1 OVERVIEW

The objective of this chapter is to evaluate and examine the capability of the ACPI in differentiating the safety level on different traffic conditions. In this chapter, three theoretical validation efforts are undertaken: the safety comparison between intersections with protected left turns and with permitted left turns; the safety comparison between intersections with and without exclusive right turn lanes; and the safety comparison between intersections with and without exclusive left turn lanes. The safety implication of those design scenarios have been analyzed based on field data and explicitly addressed in Highway Safety Manual (HSM) (AASHTO, 2010). Both proposed CPM and traditional Traffic Conflict Techniques methods are applied to determine the ACPI and TTC-based conflict indicator for multiple traffic scenarios/treatments. The ACPI and TTC-based indicator ($TTC < 1.5$ seconds) are compared with the predicated crash frequencies that are based on the HSM procedures. It should be noted that in each validation the geometry of the intersections evaluated are different but this does affect the conclusion, since each evaluation is based on the same simulated intersection that was used for the estimation of the ACPI, the TTC numbers, and the crash modification factor (CMF) analysis. Moreover, the HSM does not consider the number of approach lanes in their CMF and safety performance function (SPF) and therefore, the variation in the number of approach lanes used here is not considered as having any effect on the results.

4.2 SAFETY COMPARISON BETWEEN PROTECTED/PERMITTED LEFT TURNS

The CMF in the HSM for protected left turn per lane is 0.93 versus 1.00 for permitted left turn (AASHTO, 2010). Based on HSM, protected left turn is considered to be safer in terms of crash data. To examine and evaluate this assumption, a VISSIM model of a signalized intersection is developed. The geometry is one through lane and one dedicated left turn lane for each direction on the major road approaches and one shared lane for each direction on minor road approaches. Major street volumes range from 400 to 1000 vehicles per hour per direction with 100 vehicles per hour increments (800 to 2000 for both directions) with 30% left turn and 15% right turn. Minor street volumes are 150, 250 and 350 for each direction (300, 500, and

700 for both directions) with 15% left turn and 15% right turn. A total of 21 combinations (7 for major streets and 3 for minor streets) were examined. Each combination is simulated with both protected left turn phase and permitted left turn phase for ten repetitions. All signal timing plans are calculated based on the Highway Capacity Manual (HCM) procedures (TRB, 2000). Then, SSAM is used to extract conflict information and Matlab is utilized to generate the CPI for each conflict and ACPI for each combination. These ACPI will be compared with traditional TTC-based conflict indicator and predicted annual crash frequency (based on the SPF/CMF in HSM). The base SPF for urban/rural signalized intersections is:

$$D=CMF*e^{(-C+A*LN(ADT1)+B*LN(ADT2))} \quad (4.1)$$

Where,

D: the annual crash frequency;

C, A and B: coefficients;

CMF: the crash modification factor;

ADT1 and ADT2: average daily traffic volumes for major approaches and minor approaches, respectively.

Since two major approaches have a protected left turn phase, the CMF for protected left turn is $0.93*0.93=0.88$. The traditional TTC-based conflict indicator represents the total number of conflicts under a particular TTC threshold. The TTC threshold was suggested to be 1.5 seconds in previous research and this is the value used here (Sayed, 1994; Hayward, 1972; Minderhoud and Bovy, 2001; FHWA, 2008). The derivation of this TTC-based conflict indicator is by counting the total number of simulated conflicts with the certain TTC threshold (TTC=1.5 seconds) from the SSAM outputs. In this comparative analysis, the traditional TTC-based conflict indicator is compared with ACPI.

Table 4.1 shows the ACPI for each combination. Notably, the ratios between protected and permitted for rear-end conflict type increase drastically with the increment of traffic volume. The similar results can be also found in the final report of SSAM (FHWA, 2008) and the default driver behavior parameters of the simulation tools are considered as a possible reason of showing the high rates of the rear-end type for protected left turn design

Table 4.1 ACPI for Protected/Permitted Left Turn Volume Combinations by Conflict Type

Minor V Major V		300				500				700			
		Total	Crossing	RE	LC	Total	Crossing	RE	LC	Total	Crossing	RE	LC
800	Prot	4.39	0.49	2.26	1.63	7.26	0.55	3.45	3.27	8.91	0.28	6.17	2.47
	Perm	6.13	1.44	2.63	2.07	7.53	1.24	3.52	2.77	9.78	1.60	4.90	3.27
	Ratio	0.72	0.34	0.86	0.79	0.96	0.44	0.98	1.18	0.91	0.17	1.26	0.75
1000	Prot	6.30	0.43	3.52	2.35	8.15	0.61	4.84	2.70	12.37	1.00	8.17	3.20
	Perm	6.75	1.59	2.60	2.56	10.84	3.34	4.51	3.00	13.07	3.46	6.45	3.15
	Ratio	0.93	0.27	1.35	0.92	0.75	0.18	1.07	0.90	0.95	0.29	1.27	1.02
1200	Prot	8.93	0.37	5.89	2.67	11.14	0.52	6.53	4.10	17.40	1.82	11.56	4.02
	Perm	17.17	6.28	6.33	4.57	14.92	4.72	5.69	4.50	20.96	6.33	9.56	5.08
	Ratio	0.52	0.06	0.93	0.58	0.75	0.11	1.15	0.91	0.83	0.29	1.21	0.79
1400	Prot	10.77	0.67	6.56	3.55	14.99	0.79	10.18	4.02	22.02	1.39	15.90	4.72
	Perm	14.17	4.96	4.90	4.32	21.59	6.22	9.00	6.38	25.02	7.27	11.54	6.21
	Ratio	0.76	0.14	1.34	0.82	0.69	0.13	1.13	0.63	0.88	0.19	1.38	0.76
1600	Prot	14.28	1.14	9.29	3.85	19.90	0.57	14.88	4.45	31.74	1.20	25.27	5.28
	Perm	21.00	7.97	6.52	6.50	25.23	10.07	8.68	6.48	32.81	11.59	14.16	7.06
	Ratio	0.68	0.14	1.42	0.59	0.79	0.06	1.71	0.69	1.09	0.10	2.03	0.82
1800	Prot	17.63	0.80	12.11	4.72	31.00	0.70	23.81	6.49	49.35	0.90	41.72	0.67
	Perm	25.34	9.96	7.75	7.63	34.24	11.41	13.44	9.39	43.34	14.22	19.48	9.63
	Ratio	0.70	0.08	1.56	0.62	0.91	0.06	1.77	0.69	1.14	0.06	2.14	0.07
2000	Prot	30.05	0.53	23.11	6.41	45.05	0.47	36.46	8.11	61.14	0.00	53.80	7.34
	Perm	31.85	12.31	10.88	8.67	43.30	14.55	18.81	9.95	67.66	17.80	35.05	14.81
	Ratio	0.94	0.04	2.12	0.74	1.04	0.03	1.94	0.82	0.90	0.00	1.54	0.50

1. Prot=Protected Left Turn; Perm=permitted Left turn;
2. RE=Rear-End conflict; LC=Lane Change conflict;
3. Ratio= ACPI (pro)/ACPI (Per).

4.2.1 Ratio Comparison

Table 4.2 demonstrates the safety ratio (protected versus permitted) based on ACPI and traditional TTC-based conflict indicator. The safety ratio of ACPI ranges from 0.52 to 1.13 with mean 0.85, median 0.88 and standard deviation 0.14. The safety ratio of traditional TTC-based conflict indicator ranges from 0.77 to 1.35 with mean = 1.1, median = 1.13 and standard deviation=0.14. The data indicates that the ratio based on ACPI is more frequently close to the CMF value of 0.88 which is obtained from the HSM (Notably. 0.88 is also included in the 90% significance interval of ACPI ratio). Although the ratios based on ACPI are also larger than 1 for the two combinations (1800/700 and 2000/500), it should be noted that these two are at capacity (volume/capacity=0.99) and in such conditions traffic is possible to becomes unstable and congestion conditions may skew the results. On the contrary, most of the traditional TTC-based conflict values have mean and median larger than 1 indicating protected left turns would be more dangerous than permitted left turns which is opposite to the anticipated safety performance based on the HSM values. Therefore, ACPI has a performance that follows the anticipated HSM performance according to the ratio comparison.

Table 4.2 Ratio Comparison between ACPI, TTC-Based (<1.5s), and Predicted Crash Frequency (HSM2010)

Total		ACPI			TTC-Based (<1.5s)			HSM 2010		
Major	Minor	pro	per	Ratio	pro	per	Ratio	pro	per	Ratio
800.00	300.00	4.39	6.13	0.72	11.6	12.1	0.96	1.32	1.50	0.88
	500.00	7.26	7.53	0.96	17.1	16.8	1.02	1.48	1.68	0.88
	700.00	8.91	9.78	0.91	25	21.3	1.17	1.60	1.82	0.88
1000.00	300.00	6.30	6.75	0.93	16	14.2	1.13	1.67	1.90	0.88
	500.00	8.15	10.84	0.75	22.9	23.4	0.98	1.88	2.14	0.88
	700.00	12.37	13.07	0.95	35.2	29.7	1.19	2.03	2.31	0.88
1200.00	300.00	8.93	17.17	0.52	24.9	32.2	0.77	2.03	2.31	0.88
	500.00	11.14	14.92	0.75	27.5	28.9	0.95	2.28	2.60	0.88
	700.00	17.40	20.96	0.83	44.8	44.8	1.00	2.47	2.81	0.88
1400.00	300.00	10.77	14.17	0.76	30.2	22.34	1.35	2.40	2.72	0.88
	500.00	14.99	21.59	0.69	40.8	41.6	0.98	2.69	3.06	0.88
	700.00	22.02	25.02	0.88	59.7	51.7	1.15	2.91	3.31	0.88
1600.00	300.00	14.28	21.00	0.68	39.6	35	1.13	2.76	3.14	0.88
	500.00	19.90	25.23	0.79	53.4	46.4	1.15	3.11	3.53	0.88
	700.00	31.74	32.81	0.97	80.5	65.9	1.22	3.36	3.82	0.88
1800.00	300.00	17.63	25.34	0.70	45.1	42.1	1.07	3.13	3.56	0.88
	500.00	31.00	34.24	0.91	71.1	64.6	1.10	3.53	4.01	0.88
	700.00	49.35	43.34	1.14	110.4	85.2	1.30	3.81	4.33	0.88
2000.00	300.00	30.05	31.85	0.94	69.3	54.9	1.26	3.51	3.99	0.88
	500.00	45.05	43.30	1.04	98.8	79.4	1.24	3.95	4.48	0.88
	700.00	61.14	67.66	0.90	125.6	133.6	0.94	4.26	4.85	0.88
Statistics		Mean=0.85,Median=0.88, s.d.=0.14			Mean=1.1,Median=1.13, s.d.=0.14			Mean=0.88		

1. S.D=standard deviation;

2. Ratio=prot/perm.

4.2.2 Rank Comparison

Safety study often requires safety comparison among various transportation facilities and traffic treatments. Hence, a qualified surrogate indicator is also required to be able to differentiate relative safety in a manner similar to that of real crashes.

Rank tests were introduced to examine reliability of surrogate indicators in differentiating safety variance among different traffic treatments in the final report of SSAM (FHWA, 2008). Rank tests are nonparametric statistical tests which determine the associations between two variables. When the relationship between two variables is not linear, the relationship can sometimes be transformed into a linear one by ranking each item and using ranks instead of actual values. The advantage of the rank test is that no assumptions about the nature of the populations are required.

Here, two commonly used rank tests are performed to compare ACPI with traditional TTC-based indicator: Spearman Rank test and Kendall Tau_b Rank test.

The Spearman rank correlation coefficient (ρ_s) can be calculated as:

$$\rho = 1 - \frac{6 \sum d_i^2}{n(n^2-1)} \quad (4.2)$$

Where,

d_i : The differences between the rank based on HSM and the rank based on ACPI/TTC for the i_{th} volume combination;

n : total number of volume combinations.

The Kendall Tau_b rank correlation coefficient can be derived as:

$$\tau = \frac{(\text{number of concordant pairs}) - (\text{number of discordant pairs})}{1/2N(N+1)} \quad (4.3)$$

Where,

N : total number of pairs;

A Concordant pair means that rank order based on ACPI or TTC-based is consistent with that based on HSM for a pair of volume combinations. A discordant pair indicates that the rank order based on ACPI/TTC-based is inconsistent with that based on HSM for a pair of volume combinations. A correlation coefficient with a score of 1.0 indicates a perfect correlation between the tested two variables and a score of 0 means no correlation.

Table 4.3 shows the rank comparison between ACPI, traditional TTC-based indicator and predicted crash frequency. The pair ranks based on ACPI perform well in determining safer

combinations (19 of 21) between protected/permited left turns except for 1800/700 ($v/c=0.99$ for protected left turn) and 2000/500 ($v/c=0.99$ for protected left turn). Those two combinations are a capacity and it is possible that in such conditions traffic becomes unstable and congestion conditions may skew the results. In all, ACPI shows its capabilities to determine safety between protected/permited left turns.

Ranks based on $TTC < 1.5s$ only perform well in 6 pairs of 21 combinations (“+” indicates protected has higher rank (more conflicts) than permited for that volume combination). This indicates that the traditional TTC-based conflict indicator is far from accurate in some volume scenarios due to the failure of deciding which conditions are more “dangerous” than others.

The two rank tests also give the same result. The spearman rank correlation between ACPI and predicted crash frequency is 0.929, which is larger than 0.802 between TTC-based indicator and predicted crash frequency (HSM). The Kendall Tau-b rank correlation between ACPI and real crash frequency is 0.849 which is higher than 0.758 for TTC-based indicator. In all, CPM model outperforms the traditional TTC in terms of rank comparison results.

Table 4.3 Ratio Comparison between ACPI, TTC-Based (TTC<1.5s), and Predicted Crash Frequency (HSM 2010)

Total		ACPI					TTC-Based (TTC<1.5s)					Predicted Crash (HSM 2010)					
		prot	R	perm	R	Sign	prot	R	perm	R	Sign	prot	R	perm	R	Sign	
800.00	300.00	4.39	1	6.13	2	-	11.6	1	12.1	2	-	1.32	1	1.50	3	-	
	500.00	7.26	5	7.53	6	-	17.1	6	16.8	5	+	1.48	2	1.68	6	-	
	700.00	8.91	8	9.78	10	-	25	12	21.3	7	+	1.60	4	1.82	7	-	
1000.00	300.00	6.30	3	6.75	4	-	16	4	14.2	3	+	1.67	5	1.90	9	-	
	500.00	8.15	7	10.84	12	-	22.9	9	23.4	10	-	1.88	8	2.14	12	-	
	700.00	12.37	14	13.07	15	-	35.2	19	29.7	15	+	2.03	10	2.31	14	-	
1200.00	300.00	8.93	9	17.17	20	-	24.9	11	32.2	17	-	2.03	11	2.31	15	-	
	500.00	11.14	13	14.92	18	-	27.5	13	28.9	14	-	2.28	13	2.60	18	-	
	700.00	17.40	21	20.96	24	-	44.8	24	44.8	24	0	2.47	17	2.81	22	-	
1400.00	300.00	10.77	11	14.17	16	-	30.2	16	22.34	8	+	2.40	16	2.72	20	-	
	500.00	14.99	19	21.59	26	-	40.8	21	41.6	22	-	2.69	19	3.06	24	-	
	700.00	22.02	27	25.02	28	-	59.7	31	51.7	28	+	2.91	23	3.31	28	-	
1600.00	300.00	14.28	17	21.00	25	-	39.6	20	35	18	+	2.76	21	3.14	27	-	
	500.00	19.90	23	25.23	29	-	53.4	29	46.4	27	+	3.11	25	3.53	32	-	
	700.00	31.74	36	32.81	34	+	80.5	37	65.9	33	+	3.36	29	3.82	35	-	
1800.00	300.00	17.63	22	25.34	30	-	45.1	26	42.1	23	+	3.13	26	3.56	33	-	
	500.00	31.00	32	34.24	35	-	71.1	35	64.6	32	+	3.53	31	4.01	38	-	
	700.00	49.35	40	43.34	38	+	110.4	40	85.2	38	+	3.81	34	4.33	40	-	
2000.00	300.00	30.05	31	31.85	33	-	69.3	34	54.9	30	+	3.51	30	3.99	37	-	
	500.00	45.05	39	43.30	37	+	98.8	39	79.4	36	+	3.95	36	4.48	41	-	
	700.00	85.13	41	67.66	42	-	125.6	41	133.6	42	-	4.26	39	4.85	42	-	
R=0.849 R'=0.929						R=0.758 R'=0.802											

1. “-“ indicates protected left turn is safer than permitted left turn in the same volume combination;
2. “+” indicates permitted left turn is safer than protected left turn in the same volume combination;
3. R indicates the Tau_b correlation and R' indicates the Spearman correlation;
4. Red colors indicate those ACPI or TTC fails to correctly analyze according to predicted crash frequency;

4.3 SAFETY COMPARISON BETWEEN INTERSECTIONS WITH/WITHOUT RIGHT TURN LANES

Based on the HSM, the CMF for an intersection approach without right turn lanes on the major roads (NRB) is 1.00 versus 0.83 for with right turn lanes on both approaches of the major road (WRB). Therefore, WRB is believed to be safer in terms of historical crash data. A signalized intersection was built in VISSIM with two through lanes and one dedicated right turn lanes per approach on the major roads and one shared lane for each direction on minor roads. Left turn traffic and through traffic share the inside lane. Major street volumes range from 400 to 1200 vehicles per hour per direction with 200 vehicles per hour increments (800 to 2000 for both directions). Both left turn percentage and right turn percentage are set as 25%. Minor street volumes are 150, 300 and 450 for each direction (300, 500, and 700 for both directions) with 10% left turn and 10% right turn. A total of 15 combinations are used in this analysis.

Each combination is conducted one-hour simulation for both NRB and WRB for ten repetitions. All signal timing plans are calculated based on HCM procedures (TRB, 2000). Then, SSAM is used to filter out all conflicts for each combination and Matlab is used to apply CPM model to generate CPI for each conflict and ACPI for each combination.

Table 4.4 gives the ACPI for each combination. These ACPI will be compared with traditional TTC-based conflict indicator ($TTC < 1.5s$).

The calculation process of annual crash frequency is based on HSM. The base SPF function (Equation 4.1) has been discussed in 4.2. For intersection with right turning lanes on major approaches under no specific condition (no volume constrains), the CMF is 0.83.

Table 4.4 ACPI for With/Without Right Turn Volume Combinations by Conflict Type

Minor Volume \ Major Volume		300				600				900			
		Total	CS	RE	LC	Total	CS	RE	LC	Total	CS	RE	LC
800	NRB	9.94	3.91	3.46	2.57	13.32	3.57	5.90	3.86	17.56	4.58	8.52	4.46
	WRB	7.31	1.02	3.43	2.85	10.36	0.96	5.57	3.83	15.71	1.14	9.81	4.75
	Ratio	1.36	3.82	1.01	0.90	1.29	3.72	1.06	1.01	1.12	4.00	0.87	0.94
1200	NRB	13.08	3.52	5.52	4.05	19.14	4.22	8.79	6.13	28.33	5.28	14.57	8.48
	WRB	12.17	1.95	5.04	5.18	15.98	2.66	7.49	5.82	23.93	3.12	12.17	8.65
	Ratio	1.07	1.80	1.09	0.78	1.20	1.59	1.17	1.05	1.18	1.70	1.20	0.98
1600	NRB	21.50	5.08	8.59	7.83	31.81	7.01	15.12	9.67	47.15	7.06	28.75	11.34
	WRB	20.56	3.78	8.37	8.41	26.05	3.61	12.85	9.59	42.65	7.63	24.37	10.65
	Ratio	1.05	1.34	1.03	0.93	1.22	1.94	1.18	1.01	1.11	0.93	1.18	1.06
2000	NRB	32.39	32.39	32.39	32.39	32.39	32.39	32.39	32.39	32.39	32.39	32.39	32.39
	WRB	28.20	5.58	11.66	10.96	45.36	9.87	21.14	14.34	68.03	10.65	42.62	14.76
	Ratio	1.15	5.80	2.78	2.95	0.71	3.28	1.53	2.26	0.48	3.04	0.76	2.19
2400	NRB	58.40	10.71	30.18	17.51	113.64	15.56	78.16	19.91	246.78	14.74	209.29	22.75
	WRB	44.73	9.30	18.43	17.00	63.69	12.94	31.01	19.74	125.08	14.03	92.94	18.10
	Ratio	1.31	1.15	1.64	1.03	1.78	1.20	2.52	1.01	1.97	1.05	2.25	1.26

1. NRB indicates scenarios without right turn lanes;
2. WRB indicates scenarios with right turn lanes;
3. RE=Rear-End conflicts; LC=Lane Change conflicts; CS=Crossing conflicts.

4.3.1 Ratio Comparison

Table 4.5 demonstrates the safety ratio (WRB versus NRB) based on ACPI, traditional TTC-based conflict indicator, and predicted crash frequency (HSM). The safety ratio of ACPI ranges from 0.51 to 0.96 with the mean of 0.80, the median of 0.83 and the standard deviation 0.13. The safety ratio of TTC-based indicator ranges from 0.49 to 1.03 with the mean of 0.73, the median of 0.74 and the standard deviation of 0.15. The data indicates that the ratio based on ACPI is better than that based on TTC since the mean and median are both very close to 0.83 which is obtained from CMF factor. Moreover, 0.83 is also included in the 95% significance interval of ACPI ratio. Since ACPI has mean 0.80 and standard deviation 0.13, the 95% confidence interval of ACPI is from 0.73 to 0.86. However, the 95% confidence interval of the TTC-based conflict indicator is from 0.65 to 0.80. Moreover, the ratio based on TTC-based indicator includes some values larger than 1, showing that WRB is dangerous than NRB which is opposite to the safety estimates from HSM2010. Therefore, ACPI could be considered a better safety surrogate than Traditional TTC-based

Table 4.5 Ratio Comparison between ACPI, TTC-Based (<1.5s), and Predicted Crash Frequency (HSM 2010)

Total		ACPI			TTC-Based(<1.5s)			Predicted Crash(HSM2010)		
Major	Minor	WRB	NRB	Ratio	WRB	NRB	Ratio	WRB	NRB	Ratio
800.00	300.00	7.31	9.94	0.74	122.00	185.00	0.66	1.46	1.75	0.83
	600.00	10.36	13.32	0.78	199.00	251.00	0.79	1.71	2.06	0.83
	900.00	15.71	17.56	0.89	352.00	362.00	0.97	1.87	2.26	0.83
1200.00	300.00	12.17	13.08	0.93	173.00	232.00	0.75	2.25	2.71	0.83
	600.00	15.98	19.14	0.83	295.00	366.00	0.81	2.64	3.18	0.83
	900.00	23.93	28.33	0.84	463.00	589.00	0.79	2.89	3.49	0.83
1600.00	300.00	20.56	21.50	0.96	276.00	268.00	1.03	3.06	3.68	0.83
	600.00	26.05	31.81	0.82	472.00	622.00	0.76	3.59	4.32	0.83
	900.00	42.65	47.15	0.90	846.00	1000.00	0.85	3.94	4.74	0.83
2000.00	300.00	28.20	32.39	0.87	366.00	531.00	0.69	3.88	4.68	0.83
	600.00	45.36	48.83	0.93	711.00	999.00	0.71	4.55	5.48	0.83
	900.00	68.03	96.67	0.70	1329.00	1976.00	0.67	5.00	6.02	0.83
2400.00	300.00	44.73	58.40	0.77	583.00	992.00	0.59	4.72	5.68	0.83
	600.00	63.69	113.64	0.56	1102.00	2236.00	0.49	5.53	6.67	0.83
	900.00	125.08	246.78	0.51	2554.00	5222.00	0.49	6.07	7.32	0.83
Statistics		Mean=0.80,Median=0.83, s.d.=0.13			Mean=0.73,Median=0.74, s.d.=0.15			Mean=0.83		

4.3.2 Rank Comparison

The data in Table 4.6 indicate that both ACPI and traditional TTC-based indicator perform well in differentiating safety between NRB and WRB under same volume combination. TTC-based indicator only misreports one combination for major volume of 1600 and minor volume of 300. In 4.2.2, two rank tests have been introduced to conduct rank comparisons. In this case, ACPI and TTC both perform well in two rank tests.

The Kendall tau_b rank test results in 0.783 for TTC and 0.880 for ACPI. Although both values are very high, the ACPI still shows the advantages due to the higher value. The higher R-square indicates that the ACPI can better determine the ranks of design combinations.

The spearman rank tests also show very high values for both indicators. Still, the R-square based on ACPI are higher than that based on TTC (0.978 versus 0.933).

Based on rank comparison, the ACPI outperforms TTC in both rank tests. It shows that ACPI is more capable of differentiating relative safety among various scenarios which is similar to the anticipated results according to the HSM.

Table 4.6 Ratio Comparison between ACPI, TTC-Based (<1.5s) and Predicted Crash Frequency

Total		ACPI					TTC-Based (TTC<1.5s)					Predicted Crash (HSM 2010)					
		WRB	R	NRB	R	Sign	WRB	R	NRB	R	Sign	WRB	R	NRB	R	Sign	
800.00	300.00	7.31	1	9.94	2	-	122.00	1	185.00	3	-	1.46	1	1.75	3	-	
	600.00	10.36	3	13.32	6	-	199.00	4	251.00	6	-	1.71	2	2.06	5	-	
	900.00	15.71	7	17.56	9	-	352.00	10	362.00	11	-	1.87	4	2.26	7	-	
1200.00	300.00	12.17	4	13.08	5	-	173.00	2	232.00	5	-	2.25	6	2.71	9	-	
	600.00	15.98	8	19.14	10	-	295.00	9	366.00	12	-	2.64	8	3.18	12	-	
	900.00	23.93	13	28.33	16	-	463.00	14	589.00	18	-	2.89	10	3.49	13	-	
1600.00	300.00	20.56	11	21.50	12	-	276.00	8	268.00	7	+	3.06	11	3.68	15	-	
	600.00	26.05	14	31.81	17	-	472.00	15	622.00	19	-	3.59	14	4.32	18	-	
	900.00	42.65	19	47.15	22	-	846.00	21	1000.00	24	-	3.94	17	4.74	22	-	
2000.00	300.00	28.20	15	32.39	18	-	366.00	12	531.00	16	-	3.88	16	4.68	20	-	
	600.00	45.36	21	48.83	23	-	711.00	20	999.00	23	-	4.55	19	5.48	24	-	
	900.00	68.03	26	96.67	27	-	1329.00	26	1976.00	27	-	5.00	23	6.02	27	-	
2400.00	300.00	44.73	20	58.40	24	-	583.00	17	992.00	22	-	4.72	21	5.68	26	-	
	600.00	63.69	25	113.64	28	-	1102.00	25	2236.00	28	-	5.53	25	6.67	29	-	
	900.00	125.08	29	246.78	30	-	2554.00	29	5222.00	30	-	6.07	28	7.32	30	-	
R=0.880 R'=0.978						R=0.783 R'=0.933											

1. “-“ indicates protected left turn is safer than permitted left turn in the same volume combination;
2. “+” indicates permitted left turn is safer than protected left turn in the same volume combination;
3. R indicates the Tau_b correlation and R' indicates the Spearman correlation;
4. Red colors indicate those ACPI or TTC fails to correctly analyze according to predicted crash frequency.

4.4 SAFETY COMPARISON BETWEEN INTERSECTIONS WITH/WITHOUT DEDICATED LEFT TURN LANES

Based on the HSM, the CMF for an intersection approach without left turn lanes on major road (NLB) is 1.00 versus 0.81 for approaches with left turn lanes on both major-road approaches (WLB) for four-leg signalized urban intersections. Therefore, WLB is believed to be safer in terms of historical crash data. A signalized intersection was built in VISSIM with three through lanes and one dedicated left turn lanes per approach on major roads and one shared lane for each direction on minor roads. The right turn traffic and through traffic share the rightmost lane on each major approach. Major street volumes range from 800 to 1600 vehicles per hour per direction with 200 vehicles per hour increments (1600 to 3200 for both directions). The left turn percentage is 25% and the right turn percentage is 15%. Minor street volumes are 150, 300 and 450 for each direction (300, 500, and 700 for both directions) with 15% left turn and 15% right turn. A total of 12 combinations are used in this analysis with permitted left-turn phase plans that is determined based on HCM procedures (TRB, 2000).

Each combination is conducted one-hour simulation for both NLB and WLB for ten repetitions. All signal timing plans are calculated based on HCM procedures (TRB, 2000). Then, SSAM is used to filter out all conflicts for each combination and Matlab is used to apply CPM model to generate CPI for each conflict and ACPI for each combination.

Table 4.7 gives the ACPI for each combination. These ACPI will be compared with traditional conflict indicator (conflict numbers with $TTC < 1.5s$).

The calculation process of annual crash frequency is based on HSM. The base SPF function is Equation 4.1. For intersection with right turning lanes on major approaches under no specific condition (no volume constrains), the CMF is 0.81.

Table 4.7 ACPI for With/Without Left Turn Volume Combinations by Conflict Type

Minor V Major V	300				600				900				
	ACPI	Total	CS	RE	LC	Total	CS	RE	LC	Total	CS	RE	LC
1600	NLB	14.32	2.19	6.24	5.89	22.97	5.88	9.43	7.65	30.64	7.26	13.07	10.31
	WLB	13.23	1.46	6.02	5.75	21.31	3.16	9.11	9.03	28.36	4.37	13.65	10.34
	Ratio	1.08	1.50	1.03	1.02	1.08	1.86	1.04	0.85	1.08	1.66	0.96	1.00
2000	NLB	24.38	4.45	9.94	10.00	34.45	7.26	14.68	12.51	44.36	8.86	21.92	13.57
	WLB	22.03	3.94	9.87	8.23	31.48	6.19	13.57	11.71	40.52	6.34	19.81	14.37
	Ratio	1.06	1.13	1.00	1.22	1.08	1.17	1.05	1.07	1.09	1.40	1.11	0.94
2400	NLB	32.32	7.55	11.84	12.94	48.03	9.68	20.23	18.12	78.06	15.91	39.11	23.03
	WLB	28.76	6.35	12.23	10.19	39.05	7.21	17.66	14.18	66.62	8.50	36.90	21.21
	Ratio	1.12	1.19	0.97	1.27	1.23	1.34	1.15	1.28	1.17	1.87	1.06	1.09
3200	NLB	68.40	14.03	28.83	25.54	123.35	22.50	62.72	38.13	307.50	24.16	241.89	41.45
	WLB	57.29	12.86	24.14	20.28	103.78	15.55	59.48	28.74	186.90	11.78	130.36	44.75
	Ratio	1.19	1.09	1.19	1.26	1.19	1.45	1.05	1.33	1.65	2.05	1.86	0.93

1. NLB indicates scenarios without left turn lanes;
2. CS= Crossing conflicts; RE=Rear-End conflict; LC=Lane-Change conflicts;
3. WLB indicates scenarios with left turn lanes;

4.4.1 Ratio Comparison

Table 4.8 demonstrates the safety ratio (WLB versus NLB) based on ACPI, traditional TTC-based conflict indicator, and predicted crash frequency. The safety ratio of ACPI ranges from 0.61 to 0.93 with the mean of 0.87, the median of 0.91 and the standard deviation 0.09. The safety ratio of TTC-based indicator ranges from 0.59 to 1.00 with the mean of 0.90, the median of 0.93 and the standard deviation of 0.11. The data indicates that the ratio based on ACPI is better than that based on TTC since the mean and median are relatively more close to 0.81 which is obtained from CMF factor. Moreover, 0.81 is also included in the 95% significance interval of ACPI ratio. Since ACPI has mean 0.86 and standard deviation 0.09, the 95% confidence interval of ACPI is from 0.81 to 0.91. However, the 95% confidence interval of the conflict indicator based on $TTC < 1.5s$ is from 0.84 to 0.96. Moreover, the ratio based on TTC includes some values very close to 1, showing that WRB is as safe as NRB which is opposite to the safety estimates from HSM. Therefore, ACPI could be considered a better safety surrogate than the TTC-based indicator.

Table 4.8 Ratio Comparison between ACPI, TTC-Based (<1.5s), and Predicted Crash Frequency (HSM 2010)

Total		ACPI			TTC-Based (TTC<1.5s)			Predicted Crash(HSM 2010)		
Major	Minor	WLB	NLB	Ratio	WLB	NLB	Ratio	WLB	NLB	Ratio
1600.00	300.00	13.23	14.32	0.92	24.2	24.1	1.00	3.68	2.98	0.81
	600.00	21.31	22.97	0.93	42.2	39.5	0.94	4.32	3.50	0.81
	900.00	28.36	30.64	0.93	58.2	54.2	0.93	4.74	3.84	0.81
2000.00	300.00	22.03	24.38	0.90	39.1	39	1.00	4.68	3.79	0.81
	600.00	31.48	34.45	0.91	60.0	57.1	0.95	5.48	4.44	0.81
	900.00	40.52	44.36	0.91	81.1	77.2	0.95	6.02	4.88	0.81
2400.00	300.00	28.76	32.32	0.89	49.6	46.5	0.94	5.68	4.60	0.81
	600.00	39.05	48.03	0.81	80.7	70.8	0.88	6.67	5.40	0.81
	900.00	66.62	78.06	0.85	146.4	131.4	0.90	7.32	5.93	0.81
3200.00	300.00	57.29	68.40	0.84	106.2	89.6	0.84	7.73	6.26	0.81
	600.00	103.78	123.35	0.84	212.1	192.3	0.91	9.07	7.35	0.81
	900.00	186.90	307.50	0.61	608	357.5	0.59	9.96	8.06	0.81
Statistics		Mean=0.86,Median=0.90, s.d.=0.09			Mean=0.90,Median=0.93, s.d.=0.11			Mean=0.81		

4.4.2 Rank Comparison

The data in Table 4.9 show that both ACPI and TTC perform well in differentiating safety between NLB and WLB under same volume combination. TTC misreports two combinations with the indication showing two scenarios are equally safe. In 4.2.2, two rank tests have been introduced to conduct rank comparisons. In this case, ACPI and TTC both perform well in two rank tests.

The Kendall tau_b rank test results in 0.797 for TTC and 0.855 for ACPI. Although both values are very high, the ACPI still shows the advantages due to the higher value. The higher R-square indicates that the ACPI can better determine the ranks of design combinations.

The spearman rank tests also show very high values for both indicators. Still, the R-square based on ACPI are higher than that based on TTC (0.970 versus 0.936).

As it was the case in the previous section, the ACPI outperforms TTC in both rank tests. It shows that ACPI is more capable of differentiating safety among various scenarios in a manner similar to that of the HSM.

Table 4.9 Rank Comparison between ACPI, TTC-Based (TTC<1.5s), and Predicted Crash Frequency (HSM 2010)

Total		ACPI					TTC-Based (TTC<1.5s)					Predicted Crash (HSM 2010)					
		WLB	R	NLB	R	Sign	WLB	R	NLB	R	Sign	WLB	R	NLB	R	Sign	
1600.00	300.00	13.23	1	14.32	2	-	24.1	1	24.2	1	0	2.98	1	3.68	3	-	
	600.00	21.31	3	22.97	5	-	39.5	5	42.2	6	-	3.50	2	4.32	6	-	
	900.00	28.36	7	30.64	9	-	54.2	9	58.2	11	-	3.84	5	4.74	10	-	
2000.00	300.00	22.03	4	24.38	6	-	39	3	39.1	3	0	3.79	4	4.68	9	-	
	600.00	31.48	10	34.45	12	-	57.1	10	60	12	-	4.44	7	5.48	13	-	
	900.00	40.52	14	44.36	15	-	77.2	14	81.1	16	-	4.88	11	6.02	17	-	
2400.00	300.00	28.76	8	32.32	11	-	46.5	7	49.6	8	-	4.60	8	5.68	14	-	
	600.00	39.05	13	48.03	16	-	70.8	13	80.7	15	-	5.40	12	6.67	18	-	
	900.00	66.62	18	78.06	20	-	131.4	19	146.4	20	-	5.93	15	7.32	19	-	
3200.00	300.00	57.29	17	68.40	19	-	89.6	17	106.2	18	-	6.26	16	7.73	21	-	
	600.00	103.78	21	123.35	22	-	192.3	21	212.1	22	-	7.35	20	9.07	23	-	
	900.00	186.90	23	307.50	24	-	357.5	23	608	24	-	8.06	22	9.96	24	-	
R=0.855 R'=0.970						R=0.797 R'=0.936											

1. “-“ indicates protected left turn is safer than permitted left turn in the same volume combination;
2. “+” indicates permitted left turn is safer than protected left turn in the same volume combination;
3. “0” indicates permitted left turn is as safe as protected left turn in the same volume combination;
4. R indicates the Tau_b correlation and R' indicates the Spearman correlation;
5. Red colors indicate those ACPI or TTC fails to correctly analyze according to predicted crash frequency.

4.5 CONCLUSION

In this chapter, three simulation-based comparative analysis were conducted: the first one is on the safety comparison between intersections with protected left turns and with permitted left turns, the second is on the safety comparison between intersections with and without right turn lanes, the last one is on the safety comparison between intersections with and without right turn lanes. In each validation, ACPI were calculated and compared with a TTC-based indicator for their capabilities of identifying safety of traffic treatments under various volume scenarios. In all comparisons, ACPI outperformed the TTC-based indicator in determining anticipated safety based on the procedures suggested in the HSM. The SPF base model and CMF for the three types of traffic treatments are applied to predict the crash rates for each scenario. The ratio tests and the rank tests both show that ACPI is a more qualified surrogate measure, compared to the TTC-based indicator. This was based on the fact that the 95% confidence intervals of ratios based on ACPI include the ratios based on SPF/CMF. In addition, all ACPI have very high rank values indicating that they have a very strong agreement with SPF/CMF in identifying relative safety.

It should be noted here that the CMFs used in this chapter are applied to all crash types. This could be viewed as a limitation of the current HSM procedures, since they do not allow for safety comparison of different crash types. On the other hand, ACPI is originally designed for evaluating multiple conflict types and therefore, the ACPI has the potential to be used to address this limitation of the HSM.

5 FIELD DATA-BASED ANALYSIS

5.1 OVERVIEW

This chapter presents an analysis based in field data in order to examine if the ACPI is a qualified surrogate measure of safety. Data for three major arterials including traffic volume, lane usage, traffic signal, traffic control type and turning percentage is collected. Based on the data, simulation models were developed and calibrated using VISSIM and conducted with an one-hour simulation for ten repetitions for each. The trajectory outputs are analyzed by SSAM and then CPM to derive CPI and ACPI (the aggregation of CPI) for each VISSIM model. Then, ACPI are compared with the historical crash data for each type for each intersection. Statistical analyses are conducted to examine how well the ACPI can explain historical crash data. This will demonstrate and validate the proposed approach and allow for the use of the ACPI method for estimating and predicting crash potential based on simulated values.

5.2 DATA COLLECTION

The field validation efforts utilized 12 intersections along three major arterials in Kentucky. The three urban arterials are US31E in Bardstovwn, US31W in Elizabethtown and KY74 in Middleboro. Figure 5.1, 5.2, and 5.3 shows the three arterials which are marked with the bold lines.

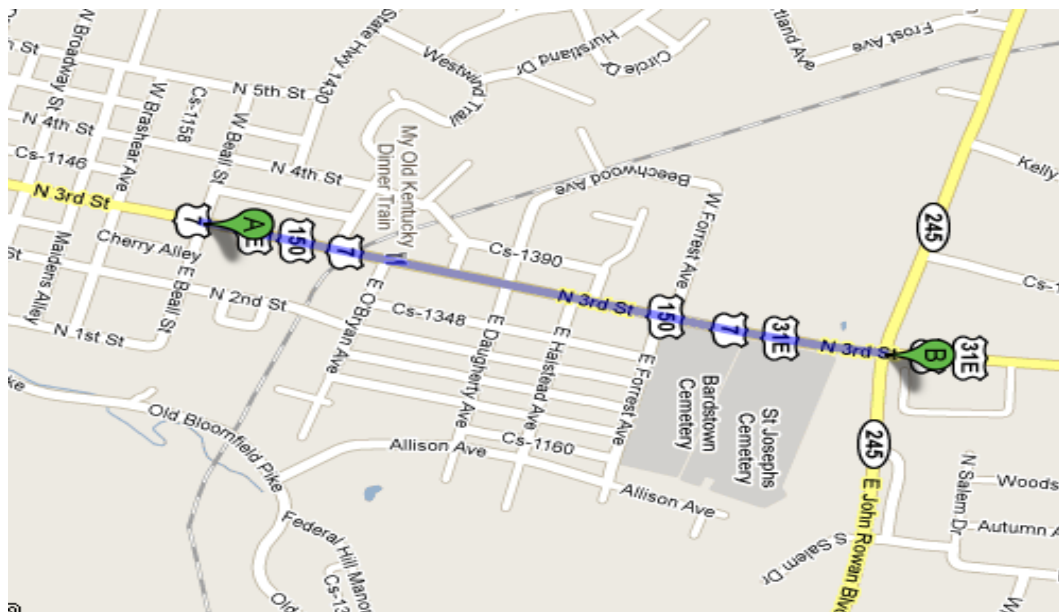

Figure 5.1 the US31E in Bardstovwn, Kentucky

For each model one-hour simulations were conducted with ten repetitions to account for the stochastic nature of the simulation. The trajectory data from each of the ten repetitions was analyzed with SSAM to develop the required data for entry into the model and estimate the hourly ACPM for each intersection. Among the 12 intersections, 11 were randomly selected as the reference group for statistical analysis and the development of prediction models. The remaining intersection was considered as the compare group with the purpose of evaluating the ACPM-based prediction models. This process was repeated for all 12 combinations, i.e. a leave-one-out cross validation was utilized, to develop the most appropriate model. Actual crash histories for these intersections for the 2007 to 2009 period were collected to estimate the Annual Crash Frequency (ACF). The crashes were filtered to include only those that are similar to the conflicts evaluated here.

Table 5.1 Selected Intersections Characteristics and Three-Year Crashes

Arterial	Intersection	No	Major/Minor Peak Volume	Major/Minor Thru Lanes	MALT/ MILT	MART/ MIRT	Total Crash	Crossing	Rear-End	Lane Change
US31	John	1	2223/1553	4/4	4/2	2/2	39	5	31	3
E	Halstead	2	1604/62	4/2	0/0	0/0	10	6	1	3
	Daughterly	3	1611/181	4/2	0/0	0/0	21	13	8	0
KY74	19th	4	1520/350	4/2	0/0	0/0	11	5	4	2
	18th	5	1519/389	4/2	2/0	0/0	9	1	7	1
	15th	6	1597/218	4/2	2/0	0/0	25	10	7	8
	22th	7	1489/218	4/2	0/0	0/0	11	1	4	6
US31	St.John	8	1725/682	4/2	2/1	1/2	19	10	5	4
W	Mantle	9	1510/286	4/2	0/0	0/1	19	11	8	0
	Miles	10	1350/530	4/2	2/2	0/0	17	14	2	1
	Mubery	11	1076/1060	4/2	2/2	0/2	18	11	6	1
	New Glendae	12	1436/386	4/2	2/0	0/1	10	7	3	0

1. MALT/MILT: Major Exclusive Left Turn Lane/Minor Exclusive Left Turn Lane;
2. MART/MIRT: Major Exclusive Right Turn Lane/Minor Exclusive Right Turn Lane.

5.3 STATISTICAL COMPARISONS

In this section, the HSM procedures utilizing the safety performance functions (SPF) and crash modification factors (CMF) were used to acquire predicted annual crash frequency (PACF) for all 12 intersections (AASHTO, 2010). The HSM provides estimation procedures for various types of intersections and also addresses the proportions for each collision type. In this study, head on and angle collisions are considered as the crossing type, rear-end collision as the rear-end type, and sideswipe collision as the lane change type. After the estimation of the PACF for each intersection, both correlation tests and Spearman rank tests were conducted to examine how the ACPI and PACF are associated with the real crash data (ACF). Table 5.2 lists the ACPI, PACF that is based on HSM, and ACF that is derived from three-year crash data for each intersection.

Table 5.2 ACPI, PACF (HSM) and ACF (Historic) of the twelve intersections

No.	ACPI				PACF (HSM)				ACF (annual crashes)			
	Total	CS	RE	LC	Total	CS	RE	LC	Total	CS	RE	LC
1	21.30	1.00	15.67	4.63	3.75	1.15	1.78	0.19	13.00	1.67	10.33	1.00
2	6.79	0.70	1.19	4.90	3.42	1.05	1.62	0.17	3.33	2.00	0.33	1.00
3	10.94	3.43	4.66	2.85	2.84	.87	1.35	0.14	7.00	4.33	2.67	0.00
4	8.03	0.13	3.44	4.46	2.58	.78	1.22	0.13	3.67	1.67	1.33	0.67
5	10.39	0.04	4.35	5.99	1.20	.37	.57	0.06	3.00	0.33	2.33	0.33
6	16.38	0.61	6.33	9.45	5.76	1.77	2.73	0.29	8.33	3.33	2.33	2.67
7	6.09	0.00	1.02	5.06	3.30	1.01	1.57	0.16	3.67	0.33	1.33	2.00
8	13.50	0.57	8.24	4.69	2.77	0.85	1.31	0.14	6.33	3.33	1.67	1.33
9	9.59	1.00	7.31	1.28	3.00	0.92	1.42	0.15	6.33	3.67	2.67	0.00
10	8.18	1.95	3.38	2.85	3.61	1.11	1.71	0.18	5.67	4.67	0.67	0.33
11	9.07	0.40	6.06	2.61	3.17	0.97	1.50	0.16	6.00	2.00	3.67	0.33
12	6.56	0.30	3.69	2.58	3.75	1.15	1.78	0.19	3.33	2.33	1.00	0.00

1. CS=crossing; RE=rear-end; LC=lane change.

Correlation tests were conducted to directly link ACPI and PACF to ACF. High and positive correlation values are noted in Table 5.2 indicating a strong relationship between the proposed ACPI and real crash frequency. This was the case for all crash types with correlation values of 0.900 for total, 0.749 for crossing, 0.897 for rear-end, and 0.822 for lane change. All these correlations were significant at the 0.01 level. It should be also noted that ACPI has much higher correlation to real crash frequency than the estimated PACF values.

Rank tests were introduced to examine ability of the surrogate indicators in differentiating relative safety among different traffic treatments/facilities in the final report of SSAM (FHWA, 2008). Rank tests are nonparametric statistical tests which determine the associations between two variables. When the relationship between two variables is not linear, the relationship can sometimes be transformed into a linear one by ranking each item and using ranks instead of actual values. The advantage of the rank test is that no assumptions about the nature of the populations are required. A correlation coefficient with a score of 1.0 indicates a perfect correlation between the tested two variables and a score of 0 means no correlation. All Spearman rank tests in Table 5.3 show high R values for ACPI: 0.788 for crossing, 0.777 for rear-end, 0.801 for lane change and 0.756 for total. The high Spearman correlations indicate that ACPI is able to identify very large proportions of rank orders based on real crash frequency. The correlation is significant at the 0.01 level. However, PACF has much smaller Spearman correlations across all types. Consequently, this tests show that ACPI can better identify the relative safety ranking among intersections as compared to PACF.

Table 5.3 Statistical Results of Correlation and Spearman Rank Correlation for ACPI and PACF

Test	Predictor	Total	Crossing	Rear-End	Lane Change
Spearman	PACF	0.301	0.203	-0.133	0.252
	ACPI	0.756	0.788	0.777	0.801
Correlation	PACF	0.736	-0.092	0.833	0.061
	ACPI	0.900	0.749	0.897	0.822

5.4 ACPI-BASED PREDICTION MODELS FOR FOUR-LEG SIGNALIZED INTERSECTIONS

Linear and non-linear regression models were tested by the leave-one-out cross validation (LOOCV) which randomly selects 11 intersections into the reference group, develops models and compares the prediction with the remaining one in the compare group. The LOOCV is repeated in such manner that each intersection in the sample is used as the testing data. Table 5.4 displays the selected models for each conflict type. The selection of the final model was based on mean square errors (MSE).

Table 5.4 ACPI-based Regression Models

Conflict Type	Equation	MSE	R ²
Total	$ACF = 0.553(\text{Total ACPM})^{0.986}$	2.196	0.70
Crossing	$ACF = 3.070 (\text{Crossing ACPM})^{0.496}$	0.870	0.83
Rear-End	$ACF = 0.483(\text{Rear-End ACPM})^{0.893}$	3.968	0.62
Lane Change	$ACF = 0.041 * (\text{Lane Change ACPM})^{1.846}$	0.324	0.67

Figure 5.4 indicates that most of the crash frequencies fall within the 95 percent confidence intervals of the predicted values according to the cross validation. The data indicates that the prediction provides reasonable estimates of the real crashes and, in general, the models perform well. It should be emphasized here that this is a very limited sample for both the reference and comparison groups and the results could be viewed only as indications of the potential of the ACPM to predict the number of crashes.

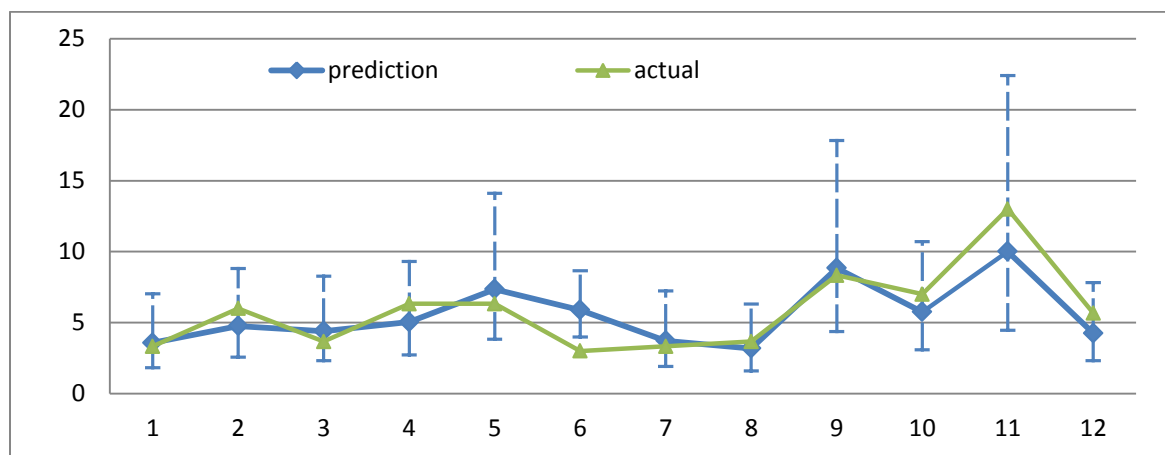

(a) Total Type

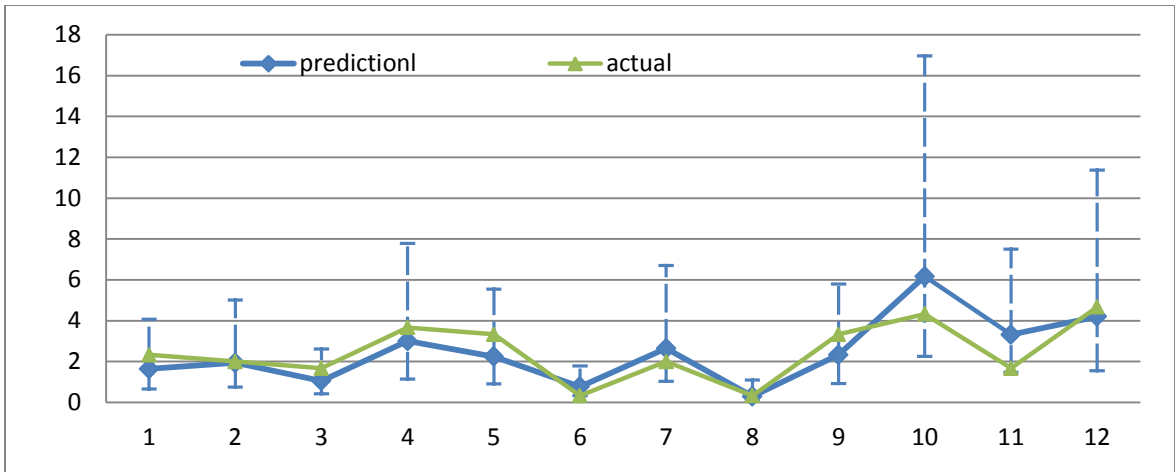

(b) Crossing Type

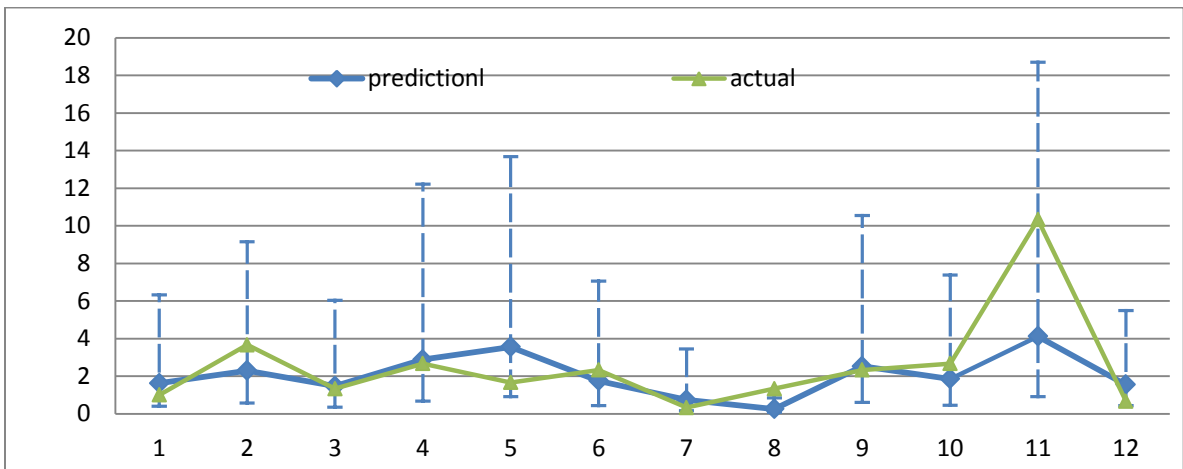

(c) Rear-End Type

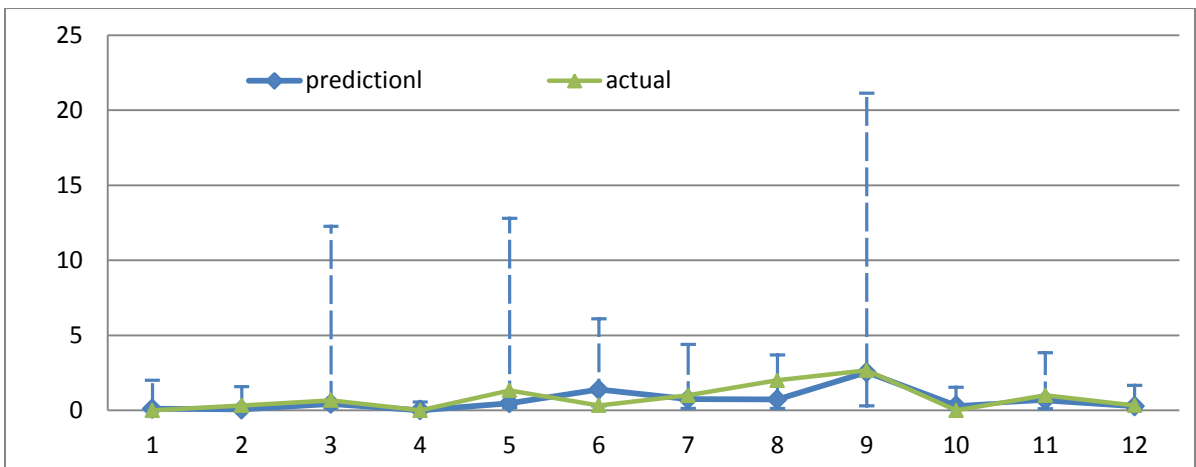

(d) Lane Change Type

Figure 5.4 the crash predictions (95% confidence interval) and the actual crash frequency

5.5 DISCUSSION AND SUMMARY

The analysis performed here showed very strong positive correlations between ACPI and historical crash frequency (ACF). The Spearman rank tests show that ACPI is able to assign and evaluate the safety rank order of traffic facilities (i.e. relative safety) and is supported by historical crash data (ACF). Prediction ACPI-based regression models are well fitted with high R2 values indicating a potential to directly link real crash frequency with the surrogate measure. The reliable prediction performance of ACPI for all conflict types allows for considering ACPI as a promising surrogate measure of safety.

Although the results are very encouraging, there are some issues that need to be mentioned here. The VISSIM simulation software generates very few crossing conflicts at signalized intersections. This is due to the fact that the simulation is developed assuming that the drivers will follow all traffic rules correctly. In the real world, crossing crashes mostly happen because of drivers' lack of attention or improper following of right of way rules. Even though VISSIM has a parameter that can control the percentage of inattentive drivers, it is very difficult to alter this parameter and thus the default value is used. Another reasonable explanation is that the use of a default PET threshold of 5.0 seconds may also have contributed to under represent crossing conflicts as the final report of SSAM noted (FHWA, 2008). These could explain the relatively low correlations for crossing incident types.

An issue that could be of concern is the different times over which the comparisons are made. The ACPI is based on hourly simulations and as such it reflects an hourly metric of safety of the location. Historical crash data are collected over long periods and as such reflect a variety of climatic and traffic patterns. The comparisons under the same time-frame and conditions can be considered as one of the future research of interests. However, this work did not consider this distinction and the aggregation of crashes was utilized. Such a research could be very difficult to be conducted due to the need to simulate each crash. Finally, there is no recalibration of the VISSIM variables to reflect environmental conditions, but all models used to predict the ACPI for each of the intersections were calibrated to reflect the driver behavior in VISSIM.

Another aspect that could affect the reliability of the result is the small number of intersections used in the validation and prediction models. It is apparent that additional intersections are needed to be examined to determine the ability and power of the proposed surrogate to predict crashes. Another aspect that should also be considered is that the models

developed here are only for four-leg regular signalized intersections. Further study is recommended with more intersections and various intersection types to further examine and evaluate the relationships between ACPI and real crashes. It should be noted though, that the regression models developed here are promising and have the potential to be used to predict the number of crashes based on ACPI and allow for evaluating other intersection designs and unique treatments. ACPI can be acquired by simulations and the number of crashes can be estimated for those cases when traditional crash prediction models cannot be applied. Intersections also need to be very carefully calibrated. Based on the current result, ACPI based on calibrated simulation models is a very reliable surrogate indicator of safety for it is well correlated with real crash frequency.

The current procedures outlined in the HSM may not be able to deal with all crash predictions and analysis, since some transportation facilities have unique characteristics that are very important but not considered by SPF and CMF. The use of simulation to develop the ACPI has the potential to improved such predictions and provide an alternative to fill this need.

6 ESTIMATION OF CRASH SEVERITY THROUGH CPM

6.1 OVERVIEW

In 3.1, 3.2 and 3.3, the CPM has been addressed to identify the crash probability of a conflict. The ACPI, which is the crash probability of a conflict, has been proved as a promising surrogate indicator of crash frequency, by comparative analysis and field-based analysis.

Crash frequency and crash severity are both important for safety studies. In order to decide the resulting crash severity of a conflict, a surrogate indicator that is associated with injury severity needs to be incorporated into CPM. This indicator is required to estimate the injury/fatal probability and can be derived from available traffic information from SSAM.

6.2 THE PROCESS OF ACQUIRING A SURROGATE INDICATOR OF CRASH SEVERITY THROUGH CPM MODEL

Delta-V is the total change in vehicle velocity before and after the crash event and it has been identified as a surrogate indicator used as a metric of crash severity (Warmbrog, 2005). DeltaV is used by most of the past research reviewed to explain the influence of speed on crash injury severity. Warmbrog (2005) proposed a logistic curve for speed and fatality probability by different types of crash in 2005. Gabauer and Gabler (2006) utilized logistic regression to explore the relationship between injury risk and DeltaV, based on the vehicle kinematics data from Event Data Recorders (EDR). In 2009, Richards and Cuerden (2009) also developed logistic regression models to address the relationships between DeltaV and different level of impacts (fatally, seriously and slightly injured) by different crash types.

The logistic model of DeltaV can be interpreted by:

$$f(\text{DeltaV}) = \frac{1}{1+e^{-(b_0+b_1 \cdot \text{deltav})}} \quad (6.1)$$

Where,

$f(\text{DeltaV})$: the injury probability of a crash;

b_0 and b_1 : parameters which entail calibration based on real world data.

Therefore, before applying DeltaV into CPM, the logistic model of DeltaV needs to be identified (many researchers have conducted this work as mentioned above). The presence of such relationship would then allow for utilizing Delta V as a surrogate indicator of crash severity.

SSAM provides the DeltaV for each conflict. However, this DeltaV is calculated without the consideration of reaction time and maximum deceleration rate. For Group A in which drivers having a specific reaction x which is larger than TTC, the crash probability can be calculated based on equation (3.1):

$$P(RT \geq TTC) = 1 - \left(\frac{1}{2} + \frac{1}{2} \operatorname{erf} \left[\frac{\ln TTC - \mu_{rt}}{\sqrt{2\sigma_{rt}^2}} \right] \right)$$

For this condition, the DeltaV reported by SSAM since the speed stays the same (no evasive actions) before the crash can be directly utilized. Therefore, the injury probability can be derived by multiplying the crash probability and $f(\text{DeltaV})$ representing the injury probability of the resulting crash.

Injury Probability = Crash Probability * $f(\text{DeltaV})$

$$= \left\{ 1 - \left(\frac{1}{2} + \frac{1}{2} \operatorname{erf} \left[\frac{\ln TTC - \mu_{rt}}{\sqrt{2\sigma_{rt}^2}} \right] \right) \right\} * \frac{1}{1 + e^{-(b_0 + b_1 * \text{deltav}_i)}} \quad (6.2)$$

For Group B-2 in which RBR exceeds the MADR, the crash probability can be calculated based on equation (3.2):

$$P = \int_0^{TTC} \frac{1}{x\sqrt{2\pi\sigma_{rt}^2}} e^{-\frac{(\ln x - \mu_{rt})^2}{2\sigma_{rt}^2}} * \frac{\Phi\left(\frac{y - \mu_{madr}}{\sigma_{madr}}\right) - \Phi\left(\frac{L_{madr} - \mu_{madr}}{\sigma_{madr}}\right)}{\Phi\left(\frac{U_{madr} - \mu_{madr}}{\sigma_{madr}}\right) - \Phi\left(\frac{L_{madr} - \mu_{madr}}{\sigma_{madr}}\right)} dx$$

For a x and a y randomly selected, there is a corresponding Delta V.

At time x , a driver realizes the potential danger and reacts. At that moment, the required braking rate is $a = \text{RBR} = \frac{2(v_{PET} - L)}{(PET - x)^2}$.

However, the maximum braking rate for this driver is only y . When the crash happens, the post velocity is $\text{PostV} = V_0 - y * (TTC - x)$. Suppose another car has $\text{PostV} = V'$ (This velocity can also be calculated), utilizing the theorem of momentum:

$$M_1 * \text{PostV}_1 + M_2 * \text{PostV}_2 = (M_1 + M_2) * V \quad (6.3)$$

Where,

M_1, M_2 : mass of each car;

V : the velocity after crash for both cars;

Then, DeltaV for each car can be computed. Therefore, the probability for a driver being involved in a severe crash with specific $RT(x)$ and $MADR(y)$ in this particular conflict condition is $\frac{1}{1 + e^{-(b_0 + b_1 * \text{deltav}_i)}}$ according to Equation (6.1).

For drivers with various reaction time and different vehicles, the total injury severity for a conflict with a specific TTC can be written as:

Injury Severity

$$= \int_0^x \frac{1}{x\sqrt{2\pi\sigma_{rt}^2}} e^{-\frac{(\ln x - \mu_{rt})^2}{2\sigma_{rt}^2}} * \frac{\Phi\left(\frac{y - \mu_{madr}}{\sigma_{madr}}\right) - \Phi\left(\frac{L_{madr} - \mu_{madr}}{\sigma_{madr}}\right)}{\Phi\left(\frac{U_{madr} - \mu_{madr}}{\sigma_{madr}}\right) - \Phi\left(\frac{L_{madr} - \mu_{madr}}{\sigma_{madr}}\right)} dx * \frac{1}{1 + e^{-(b_0 + b_1 * \text{deltav}_i)}} + \left\{1 - \left(\frac{1}{2} + \frac{1}{2} \text{erf} \left[\frac{\ln TTC - \mu_{rt}}{\sqrt{2\sigma_{rt}^2}} \right]\right)\right\} * \frac{1}{1 + e^{-(b_0 + b_1 * \text{deltav}_i)}} \quad (6.4)$$

Although mentioned here, the process and indicator will not be discussed and validated in the following chapters because the main objective of the research focuses on developing the CPI. It is therefore recommended to examine the injury severity indicator in future research.

6.3 CONCLUSION

In this chapter, the process of acquiring a surrogate indicator for injury severity is discussed here to show the potential of the CPM in expanding its capabilities to deal with crash severity in addition to crash probability of simulated conflicts. DeltaV is an indicator commonly used to determine the injury probability. Since one particular combination of a driver and a car can produce a DeltaV for a specific scenario, there is an injury probability assigned to that combination. By conducting Monte-Carlo process, an aggregation of injury probability for a conflict can be derived. This aggregation of injury probability is suggested as a surrogate indicator for injury severity. However, this process need to be further examined and validated.

7 CONCLUSIONS AND FUTURE RESEARCH

7.1 CONCLUSIONS

Traffic safety is one of the most essential aspects of transportation engineering. The planning, design, and maintenance of transportation facilities should consider the impacts of crashes when designing or evaluating alternative designs. Since crash frequency is a direct measure of traffic safety, the development of crash prediction models is able to give policy-makers, planners and traffic engineers a clear insight into past, current and future safety. Hence, crash prediction models play a very important role in safety study and need to be carefully examined to ensure their accuracy and reliability. However, most crash prediction models are statistically-based methods requiring significant efforts on crash data collections. Moreover, the statistical-based prediction methods may not be applied in particular traffic environments due to the limitation of data sources.

Therefore, it is necessary to find surrogate metric instead of traffic crashes. Compared to traffic crash that is an infrequent incident in real world, traffic conflict is considered to be a more frequent incident type and share the similar distribution to traffic crash. The studies on traffic conflicts have been conducted for years with the purposes of developing a qualified safety surrogate. Traditional traffic conflict studies are mostly field-based studies depending on manual counting, which is also labor-intensive and inaccurate. The video-techniques can help eliminate the work on field observation but still difficult to extract accurate data due to its two-dimensional nature. Nowadays, simulation tools are more and more utilized in traffic studies. With the development of computer science, they are capable of establishing a simulated traffic environment similar to the real world. Moreover, due to its automatic recording mechanism, the data can be derived easily and more accurate. However, there is not a qualified surrogate indicator that is widely accepted in conflict studies. Most existing indicators are not able to identify the crash potential of conflicts in a quantified way.

The primary objective of this research is to develop an indicator as a qualified surrogate measure for simulation-based conflict studies. This indicator is expected to be able to quantify the crash potential of conflicts, by considering multiple factors including conflict characteristics, human differences and vehicle variances.

This research provides the following major contributions.

A Conflict Propensity Index (CPI) was developed aiming at determining the crash probabilities of traffic conflicts. The CPI incorporates the human reaction times and braking limitations, which are the two most important factors affecting crashes. The Aggregated Conflict Propensity Index (ACPI) can be derived by aggregating the CPI for each conflict to determine the safety of this particular type.

A Conflict Propensity Model (CPM) was developed for deriving the CPI and ACPI. The CPM is able to provide ACPI for three different conflict types: crossing, rear-end and lane change. This achievement allows the full safety examination of intersections which includes various conflict types. Besides, the CPM is also addressed its potential of expanding the capability of studying on injury severity of crash, by combining a surrogate indicator of injury severity.

A series of efforts were conducted on examining the reliability of ACPI. Three simulation-based comparative studies were conducted to examine how ACPI identified the safety of special traffic treatments. ACPI outperformed the traditional TTC indicator and provided similar results to SPF/CMF. The field-based analysis showed that ACPI was highly correlated with real crash frequency and able to explain the safety rank orders among multiple traffic facilities. ACPI-based prediction models for signalized intersections were also well fitted. All tests provided encouraging results showing that ACPI is a promising surrogate indicator based on simulation conflict studies and ACPI-based prediction models have the potential to be utilized as a supplementary method of SPF/CMF in the future.

7.2 RECOMMENDATIONS AND FUTURE RESEARCH

Though this dissertation provides several contributions to simulation-based conflict studies and surrogate measure of safety, there are still some work needs to be done in the future.

First of all, this dissertation only conducted validation efforts on ACPI, which is a surrogate indicator of crash frequency. Although in the dissertation a surrogate indicator of injury severity was introduced, no validation efforts were conducted. This work needs to be finished in the future.

Secondly, the distribution of drivers' reaction times was borrowed from other research. One drawback is that crossing and lane change conflict types lack a dedicated reaction time distribution. This gap is expected to be filled in order to improve the CPM model and thus make CPI more accurate.

Thirdly, the criteria of categorizing traffic conflicts were borrowed from the previous research. When looking into the simulation outputs, there are still some conflicts identified to be categorized into wrong conflict types. Hence, the criteria of classifying conflict types need to be future examined and improved. The current version of SSAM also needs to update the algorithm when new researches are performed.

Fourthly, only twelve signalized intersections were incorporated in the field validation. The small number of validation points may limit the findings of this validation. Further study is recommended with more intersections to develop the relationship between crashes and ACPI. Intersections also need to be very carefully calibrated.

Finally, the ACPI prediction models for four-leg signalized intersections developed in this research need to be further validated and improved due to the limited sample size. Also, other ACPI prediction models for specific usage (e.g. unsignalized intersections, roundabout, and interchanges) need to be developed and validated in the future research.

APPENDIX A: MATLAB CODE

```
clear all
a=load ('J:\1.txt');
[Y,Z]=size(a);
for j=1:Y;
N=10000;
m=0;
n=0;
l=0;
v=0;
p=0;
e(j,2)=abs(a(j,2));
t(j)=(a(j,3)+a(j,4)/tan(e(j,2)*pi()/180)+a(j,7)/sin(e(j,2)*pi()/180))/(2*a(j,5));
if a(j,5)==0;
    t(j)=0;
end
k(j)=a(j,3)/a(j,5);
if a(j,5)==0;
    k(j)=0;
end
r= lognrnd (0.1629, 0.4461, N, 1);
s= lognrnd (-0.1277, 0.2976, N, 1);
y= normrnd (9.7, 1.3, N, 1);
low=find(y<4.2);
y(low)=4.2;
upp=find(y>12.7);
y(upp)=12.7;
if a(j,9)==1;
for i=1:N;
if
a(j,5)==0&&r(i)<a(j,1)&&y(i)>a(j,8)^2/(2*a(j,8)*a(j,1)-a(j,8)*r(i))||a(j,5)>0&&(2*a(j,8))*(t(j
```

```

)-a(j,1))/(t(j)-r(i))^2)*(t(j)+a(j,1)-r(i))>a(j,5)&& r(i)<a(j,1)&&
y(i)>a(j,8)^2/(2*a(j,8)*a(j,1)-a(j,8)*r(i))||a(j,5)>0 && r(i)<a(j,1)&&
y(i)>2*a(j,8)*(t(j)-a(j,1))/(t(j)-r(i))^2;
    m=m+1;
end
end
I(j)=(N-m)/N;
G(j)=(N-m)/N;
    elseif a(j,9)==2;
        for q=1:N;
            if s(q)<a(j,1)&& y(q)>(a(j,8)-a(j,5))/(2*(a(j,1)-s(q)));
                n=n+1;
            end
        end
        I(j)=(N-n)/N;
        L(j)=(N-n)/N;
    elseif a(j,9)==3;
        for w=1:N;
            if
r(w)<a(j,1)&&y(w)>max((a(j,8)-a(j,5))^2/(2*(a(j,8)*(a(j,1)-r(w))+0.5*cos(e(j,2)*pi()/180)*a
(j,3)+a(j,5)*r(w)-a(j,3)-0.5*a(j,6))), (2*k(j)*a(j,8)-a(j,6)+a(j,3)*cos(e(j,2)*pi()/180))/(a(j,1)+k
(j)-r(w))^2);
                l=l+1;
            elseif
r(w)<a(j,1)&&y(w)<(2*k(j)*a(j,8)-a(j,6)+a(j,3)*cos(e(j,2)*pi()/180))/(a(j,1)+k(j)-r(w))^2||r(
w)>a(j,1);
                v=v+1;
            end
        end
        T(j)=v/N;
        I(j)=v/N;
        K(j)=(N-l)/N;
    end

```

```
end
B=I';
E=K';
F=T';
A=sum(G(:))/10
C=sum(L(:))/10
D=sum(K(:))/10
H=sum(T(:))/10
M=[A+C+D,A,C+D-H,H,C,D]
```

REFERENCES

- American Association of State Highway and Transportation Officials (AASHTO). *Highway Safety Manual*, 1st Edition, Volumes 1, 2, and 3, Washington, D.C., 2010.
- Amundsen, F., and Hyden, C. *Proceedings of First Workshop on Traffic Conflicts*. Oslo, Institute of Transport Economics, 1997.
- Archer, J. *Indicators for Traffic Safety Assessment and Prediction and Their Application in Micro- Simulation Modeling Study of Urban and Suburban Intersections*. Sweden Royal Institute of Technology, Stockholm, Bonsalla, 2005.
- Barcelo, J. et al. Safety Indicators for Micro Simulation-Based Assessments. *Transportation Research Board Annual Meeting*, Washington, D.C., 2003.
- Caflich, R. E. *Monte Carlo and Quasi-Monte Carlo Methods*, Acta Numerica vol. 7, Cambridge University Press, 1998, pp. 1-49.
- Chin, H.C. and Quek, S.T. Measurement of Traffic Conflicts. *Safety Science*. Vol 26, Page 169-185, 1997.
- Cooper, F. and Ferguson, N. Traffic studies at t-junctions - a conflict simulation model. *Traffic Engineering and Control*, Vol.17, 1976, pp.306–309.
- Cooper, P.J. *Experience with Traffic Conflicts in Canada with Emphasis on Post Encroachment Time Techniques*. In International Calibration Study of Traffic Conflicts, NATA ASI Series, Vol. F5, Springer-Verlag, Heidelberg, Germany, 1983, pp.75-96.
- Cunto, F. *Assessing Safety Performance of Transportation Systems using Microscopic Simulation*, Waterloo, Ontario, Canada, 2008
- Marc Green. “How Long Does It Take to Stop?” Methodological Analysis of Driver Perception-Brake Times, *Transportation Human Factors*, 2(3), 2008, pp.195–216.
- Davis, G., Hourdos, J., and Xiong, H. Outline of a Causal Theory of Traffic Conflicts and Crashes, *Proceedings of 87th Annual TRB Meeting*, Washington, DC, 2008.
- Evans, L. *Traffic Safety and the Driver*. New York: Van Nostrand Reinhold. 1991, pp. 77-83, 282-306, 313-320.
- Fambro, D., Fitzpatrick, K., and Koppa, R. *Determination of Stopping Sight Distances*, NCHRP Report 400, National Academy Press, Washington DC, 1997.
- Federal Highway Administration. *Surrogate Safety Assessment Model and Validation: Final Report*. FHWA-HRT-08-051, 2008.

- Federal Highway Administration. *Surrogate Safety Measures from Traffic Simulation Models, Final Report*. Publication No.FHWA-RD-03-050, USA, 2003.
- Fitzpatrick, K. et al. *Accident Mitigation Guide for Congested Rural Two-Lane Highways*, NCHRP report 440, National Academy Press, Washington, DC, 2000.
- Gabauer, D. J. and Gabler, H. C. *Comparison of Delta-V and Occupant Impact Velocity Crash Severity Metrics Using Event Data Recorders*, Center for Injury Biomechanics Virginia Tech Blacksburg, VA., 2006.
- Garber, N.J., and Gadiraju, R. *Speed Variance and its Influence on Accidents*, *AAA Foundation for Traffic Safety*, Washington D.C., USA, 1988.
- Haas, K.J. Overview of the AASHTO Highway Safety Manual. Oregon Department of Transportation. *ACEC/ODOT Liaison Committee Meeting*, 2009.
- Hauer, E. and Garder, P. Research into the Validity of The Traffic Conflicts Technique. *Accident Analysis and Prevention*, Vol.18, 1986, pp.471–481.
- Hayward, J. *Near Miss Determination through Use of A Scale of Danger*. Report No. TTSC, 1972.7715, Pennsylvania State University, Penn., USA.
- Hyden, C. *The development of a Method for Traffic Safety Evaluation: The Swedish Traffic Conflicts Technique*. Bulletin 70, Dept. of Traffic Planning and Engineering, Lund University, Lund, Sweden, 1987.
- Hyden, C. *Traffic Conflicts Technique: State-of-the-art*. In: *Topp H.H. (Ed.), (1998). Traffic Safety Work with video-processing*. University Kaiserslautern. Transportation Department, 1998, Green Series No.43.
- Kruyssen, H. The Subjective Evaluation of Traffic Conflicts Based on An Internal Concept of Dangerousness, *Accident analysis and prevention*. Vol. 23, No. 1, 1991.
- Malkhamah, S., Tight, M., and Montgomery, F. The Development of An Automatic Method of Safety Monitoring at Pelican Crossings. *Accident Analysis and Prevention*, Vol. 37, 2005, pp. 938–946.
- McDowell, M.R.C., Wennell, J., Storr, P.A., and Darzentas, J. *Gap Acceptance and Traffic Conflict Simulation as a Measure of Risk*. Technical report, Transportation and Road Research Laboratory - Supplementary Report 776, 1983.
- Minderhoud, M. M., and Bovy, P. H. L. Extended Time-to-Collision Measures for Road Traffic Safety Assessment, *Accident Analysis and Prevention*, Vol. 33, 2001, pp.89-97.
- MOV'IT Database. <http://www.monteverdiclub.com/rahmen/stoptbl.ht.m> Last Access Date: November, 2010.

- National Automotive Sampling System (NASS). <http://www-nass.nhtsa.dot.gov/nass/cds-new/SearchForm.aspx>. Last Access Date: November, 2010.
- Ozbay, K., Yang, H., Bartin, B., and Mudigonda, S., Derivation and Validation of New Simulation-Based Surrogate Safety Measure, *Transportation Research Record*, 2008.
- Perkins, D. and Bowman, B. Effectiveness Evaluation by Using Non-Accident Measures of Effectiveness. *Transportation Research Record*, Vol. 905, 1982.
- Perkins, S.R. and Harris, J.I. *Criteria for Traffic Conflict Characteristics*. Report. GMR632, Warren, MI, General Motors Corporation, 1967.
- Richards, D., Cuerden, R., and Britain, G. *The Relationship between Speed and Car Driver Injury Severity*, Transport Research Laboratory, Department for Transport: London, 2009.
- Sayed, T. et al., Simulation of Traffic Conflicts at Unsignalized Intersections. *Accident Analysis and Prevention*, Vol. 26, No 5, 1994.
- Songchitruksa, P. and Tarko, A. The extreme value theory approach to safety estimation. *Accident Analysis & Prevention*, Vol.38, 2006, pp. 811-822.
- Songchitruksa, P. and Tarko, A.P. *Using Imaging Technology to Evaluate Highway Safety*. Report FHWA/IN/JTRP-2004, Grant No. SPR-2663, Purdue University, 2004.
- Summala, H. "Brake Reaction Times and Driver Behavior Analysis." *Transportation Human Factors*, 2(3), 2000, pp. 217–226.
- Taaka, G T. Break Reaction Times of Unaltered Drivers, *ITE Journal*, Vol. 59, 1989.
- Tarko, A. et al. *White Paper: Surrogate Measures of Safety*. Committee on Safety Data Evaluation and Analysis (ANB20), 2009.
- Thompson, H. and Perkins, D. Surrogate Measures for Accident Experience at Rural Isolated Horizontal Curves, *Annual meeting of Transportation Research Board*, Washington, DC, 1983.
- Tiwari, G. et al. Conflict Analysis for Prediction of Fatal Crash Locations in Mixed Traffic Streams, *29th annual proceedings of the association for advancement of automotive medicine*. Oct 16-18, Chicago, Il, 1995.
- Topp, H.H. *Traffic Safety Work with Video-Processing*. University Kaiserslautern. Transportation Department, 1998, Green Series No.43, Kaiserslautern, Germany
- Triggs, T. and Harris, W. *Reaction Time of Drivers to Road Stimuli*. Technical Report, Monash University, Human Factor Group, Department of Psychology, 1982.

- Van der Horst, R., and Kraay, J. The Dutch Conflict Observation Technique – DOCTOR. *Proceedings of Workshop - Traffic Conflicts and Other Intermediate Measures in Safety Evaluation*, Budapest, Hungary, 1986.
- Vogel, K. Modeling Driver Behavior – *A Control Theory Based Approach*, Institute of Technology, University of Linkoping, Linkoping Studies in Science and Technology, Dissertation No. 751, Sweden, 2003.
- Wramborg, P. A new approach to a safe and sustainable road structure and street design for urban areas, *Proceedings of the Road Safety on Four Continents Conference*, Warsaw, Poland, 2005.

VITA

DATE AND PALCE OF BIRTH

September 9, 1985

Nanjing, Jiangsu Province, P.R. China

EDUCATION

M.S., Transportation Enigneering, Southeast Univerisy, Nanjing, P.R.China, April 2009.

B.S. , Transportation Enigneering, Southeast Univerisy, Nanjing, P.R.China, April 2007.

RESEARCH EXPERIENCE

Graduate Research Assistant/Teaching Assistant, University of Kentucky, 2009 to Present.

Graduate Research Assistant, Southeast University, P.R.China, 2007 to 2009.

SELECTED PUBLICATIONS

Chen Wang and Nikiforos Stamatiadis. A Surrogate Safety Measure for Simulation-Based Conflict Study. Proceedings of the 92nd Annual Meeting of Transportation Research Board, Washington, D.C., USA, January. 2013.

Chen Wang and Nikiforos Stamatiadis. Bicyclist Injury Severity in Bicycle-Motor Vehicle Crashes at Unsignalized Intersections in Kentucky. Proceedings of the 90th Annual Meeting of the Transportation Research Board, Washington, D.C., USA, January 2011.

Chen Wang and Jun Chen. Multi-attribute Decision Based on Grey Game Theory with Mixed Strategy. 2009 International Conference on Advanced Computer Control, Singapore January 22-24, 2009